



Pro
one

PRODUKT KATALOG

**SCHALUNGS- UND BEWEHRUNGS-
ZUBEHÖR**

Impressum

April 2024

Herausgeber:

BR Bauhandel AG

Riedmattstrasse 2

8153 Rümlang

www.baubedarf.ch

Zu den AGBs:



Verkaufs-, Liefer- und Zahlungsbedingungen

Der Verkauf unserer Produkte unterliegt unseren Verkaufs-, Liefer- und Zahlungsbedingungen, die u.a. auf unserer Internetseite www.baubedarf.ch publiziert sind. Die Bilder sind unverbindlich. Zwischenverkauf und Sortimentsänderungen sind vorbehalten.

ProOne

DIE NR. 1 FÜR PROFIS



Pro
one

WERKZEUGE UND MATERIALIEN FÜR PROFIS

ProOne der zuverlässige Partner
für die täglichen Handwerkerbedürfnisse aller Sparten.
ProOne hat die Werkzeuge und Materialien. Für alle
Bau- und Umbauprojekte. Für alle Handwerker Profis.
Kompromisse bei der Qualität gibt's keine.

ProOne – Von Profis für Profis

www.pro-one.ch

DISTANZKÖRBE

Distanzkörbe mit Fuss



Distanzkörbe mit Fuss 13

Distanzkörbe ohne Fuss



Distanzkörbe ohne Fuss 18

BEWEHRUNGSTECHNIK

Rückbiegeanschluss



BE-BOX® Standard einschnittig 20



BE-BOX® Standard zweischnittig 21



BE-BOX® Standard Konsole 24



BE-BOX® Standard Doppelkasten 25



BE-BOX® Quer + Längs Verzahnung 26

Einzel Schubdorne



Einzel Schubdorn in 1.4462 27



Einzel Schubdorn in 1.7227 roh 29



Einzel Schubdorn in 1.7227 verzinkt 30



Einzel Schubdorn in 1.4362 31



Kunststoff-Gleithülse 32



Gleithülse aus Edelstahl 32



Q-Edelstahlhülse 33

BEWEHRUNGSZUBEHÖR

Abstandhalter



Drunterleiste mit Aussparung 36



Drunterleiste mit Aussparung verstärkt 37



Raster-Fix 38

BEWEHRUNGSZUBEHÖR

Abstandhalter

	Drunterleiste voll mit Loch	38
	Drunterleiste voll mit Loch verstärkt	39
	DRUPAK	40
	DRUWA Abstandhalter	41
	Kamm Abstandhalter	41
	Ringabstandhalter	42
	Flügeli Abstandhalter	43
	Abstandhalter 4 Fuss Flach	44
	Abstandhalter 4 Fuss Spitzig	44
	BE-BETONABSTANDHALTER® Typ RL	45
	BE-BETONABSTANDHALTER® Typ RS	46

BEWEHRUNGSZUBEHÖR

Abstandhalter

	BE-BETONABSTANDHALTER® Typ 3D	47
	BE-BETONABSTANDHALTER® Typ 3K	48
	BE-BETONABSTANDHALTER® Typ RK	49
	BE-BETONABSTANDHALTER® Typ 4K	50
	BE-BETONABSTANDHALTER® Typ RD	50
	BE-BETONABSTANDHALTER® Typ PRO	51
	Flächenabstandhalter Dreikant	52
	Flächenabstandhalter Vierkant	53
	Flächenabstandhalter Dreikant Schlange	54

Arbeitssicherheit

	Schutzprofil SICURO	55
---	----------------------------	----

Federstahlbinder



Federstahlbinder 55

Drahtbinder



Drahtbinder geschweisst verkupfert 56



Drahtbinder geschweisst verzinkt 57



Drahtbinder geschweisst rostfrei 58



Drahtbinder doppelt geschweisst verkupfert 59



Drahtbinder geschlauft schwarz 59

SCHALUNGSZUBEHÖR

Distanzrohre



BE-OPTI 63



BE-OPTI Konus 64

SCHALUNGSZUBEHÖR

Distanzrohre



BE-OPTI Stopfen 64



BE-GON® STANDARD 65



BE-GON® STANDARD KONUS 66

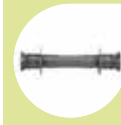

BE-GON PLUS® ø22 66



BE-GON® + BEGON PLUS® Stopfen 67



BE-GON PLUS® Sichtbetonscheibe aus Giessbeton 68



BE-GON PLUS® Sichtbetonstopfen Kunststoff 68



BE-GON PLUS® Sichtbetonscheibe Edelstahl gedreht 69



BE-GON PLUS® Sichtbetonscheibe Edelstahl poliert 69



BE-GON® PLUS® Konus 70



BE-KON® mit Konen 70

SCHALUNGSZUBEHÖR





Distanzrohre

	Distanzrohre	71
	BE-KON® Konus	72
	BE-KON® Stopfen	72
	BE-KON® Dicht Stopfen	73
	BE-KON® Sichtbeton Konus	74
	BE-SCHAL® Schalstopfen	74
	Faserbetonrohr	75
	Faserbetonstopfen	75
	Probeton	76

Anschlaghalterung

	Filou Frischbeton	77
---	--------------------------	----

Anschlaghalterung

	Filou 1E	77
	Filou 1D	78
	Filou 2E	79
	Filou 2D	80

Winkel und Zubehör

	BE-WINKEL® PRONTO	80
	BE-WINKEL® UNIVERSAL	81
	BE-WINKEL® Zembord UNIVERSAL	81
	Klemmwerkzeug	82
	Seitenschutzpfosten	82
	Transportbehälter	83



DYWIDAG

	Gewindestahl 15/17mm	83
	Gewindestahl 15/17mm verzinkt	84
	Wassersperre G65	84
	Beton- und Felsanker	85
	Ankerplatte	85
	Fixanker für Gewinde	86
	Kupplung	86
	Flügelmutter	87
	Kalottenplatte	87
	Sechskantmutter	88
	Teller Mutter	88
	Verbindungsuffe	89

Schalungsprofile

	Holzdreikantleisten	89
	Dreikantleisten mit Nagelfahne	90
	Dreikantleisten mit Nagelfahne hohl	90
	Dreikantleisten hohl aus Kunststoff	91
	Dreikantleisten hohl mit Steg aus Kunststoff	91
	Holz Trapezleisten	92
	Abtropfprofil aus Kunststoff	93
	Wassernasen aus Kunststoff	93

Ankerhülsen

	Betonhülse aus Edelstahl	94
	Betonhülse aus Kunststoff	94

ZEMBORD

	Zembord	95
	Zembord WD-F	96
	Zembord WD-P	98
	Zembord Winkel WD	100
	Zembord WD-I	100
	RONDO light	101

RAPIDOBORD

	Rapidobord	102
---	------------	-----



DIVERSE BAUPRODUKTE

Montageplatten

	Unterlagsplatten Typ V	104
---	------------------------	-----

DIVERSE BAUPRODUKTE

Montageplatten

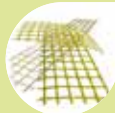
	Unterlagsplatten mit Schlitz	105
	Distanzplatten	106
	Mauerwerksarmierung	107

Holzkeile

	Holzkeile Hart	107
---	----------------	-----

Drahtstifte

	Drahtstifte Standard	108
	Doppelkopfstifte	108

Kunststoffnagel



Kunststoffnagel

109

Schachtleitern



Schachtleitern verzinkt

110



Schachtleitern inox

111



Doppelbriden

112



Einsteighilfen

112

DISTANZKÖRBE



Distanzkörbe mit Fuss 13

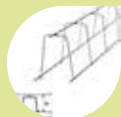

Distanzkörbe ohne Fuss 18

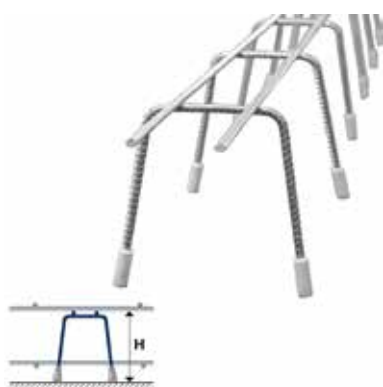

Distanzkörbe mit Fuss

Distanzkörbe mit Kunststoff-Füssen können schnell und einfach auf der Baustelle verlegt werden. Die Distanzkörbe sind extrem stabil und massgenau, damit die Betondeckung und der Abstand der statisch relevanten Armierung eingehalten werden kann.







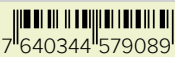
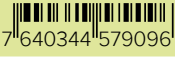
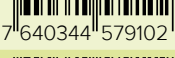
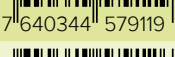
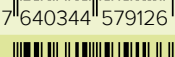
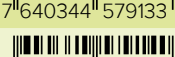
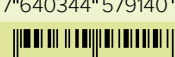
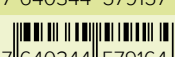

Höhe 60 – 1500 mm

- Stücklänge 2.50 Meter
- 1 Bund entspricht 10 Stk.
- Werkbunde können individuell zusammengestellt werden

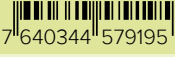
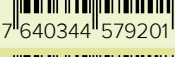
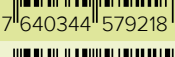
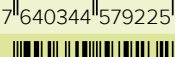
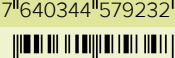
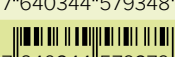



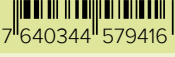
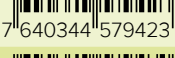
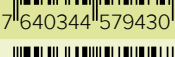
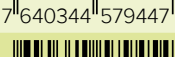
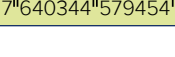







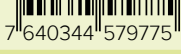
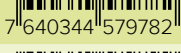
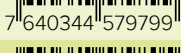
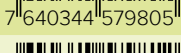
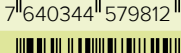
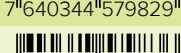
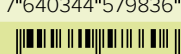
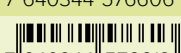



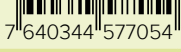
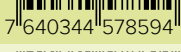
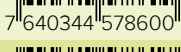
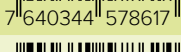
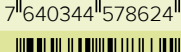
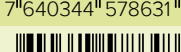
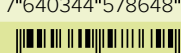
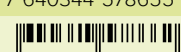

QR-Code klickbar

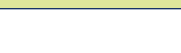
Artikelnummer	EAN Code	Teilung mm	Höhe mm	Breite oben mm	Bund / Werksbund	Preis CHF	ME
8139084	7 ⁶⁴⁰³⁴⁴ 578945	200	40	85	25m / 500m	16.50	m
8139085	7 ⁶⁴⁰³⁴⁴ 578952	200	50	85	25m / 500m	16.50	m
8139086	7 ⁶⁴⁰³⁴⁴ 578969	200	60	85	25m / 500m	16.50	m
8139087	7 ⁶⁴⁰³⁴⁴ 578976	200	70	85	25m / 2000m	6.45	m
8139088	7 ⁶⁴⁰³⁴⁴ 578983	200	80	85	25m / 2000m	6.45	m
8139089	7 ⁶⁴⁰³⁴⁴ 578990	200	90	85	25m / 2000m	6.45	m
8139090	7 ⁶⁴⁰³⁴⁴ 579010	200	100	85	25m / 1800m	6.45	m
8139091	7 ⁶⁴⁰³⁴⁴ 579034	200	110	85	25m / 1575m	6.95	m
8139092	7 ⁶⁴⁰³⁴⁴ 579041	200	120	85	25m / 1575m	6.95	m
8139093	7 ⁶⁴⁰³⁴⁴ 579058	200	130	85	25m / 1575m	6.95	m
8139094	7 ⁶⁴⁰³⁴⁴ 579065	200	140	85	25m / 1575m	6.95	m
8139095	7 ⁶⁴⁰³⁴⁴ 579072	200	150	85	25m / 1575m	6.95	m

Artikelnummer	EAN Code	Teilung mm	Höhe mm	Breite oben mm	Bund / Werksbund	Preis CHF	ME
8139096	 7 ⁴ 640344 ⁴ 579089	200	160	85	25m / 1575m	7.60	m
8139097	 7 ⁴ 640344 ⁴ 579096	200	170	85	25m / 1575m	7.60	m
8139098	 7 ⁴ 640344 ⁴ 579102	200	180	85	25m / 1200m	7.60	m
8139099	 7 ⁴ 640344 ⁴ 579119	200	190	85	25m / 1200m	7.60	m
8139100	 7 ⁴ 640344 ⁴ 579126	200	200	85	25m / 1200m	7.60	m
8139101	 7 ⁴ 640344 ⁴ 579133	200	220	85	25m / 1200m	11.30	m
8139102	 7 ⁴ 640344 ⁴ 579140	200	240	85	25m / 875m	11.30	m
8139103	 7 ⁴ 640344 ⁴ 579157	200	260	85	25m / 875m	11.30	m
8139112	 7 ⁴ 640344 ⁴ 579164	200	280	85	25m / 875m	11.30	m
8139113	 7 ⁴ 640344 ⁴ 579171	200	300	85	25m / 750m	11.30	m
8139114	 7 ⁴ 640344 ⁴ 579188	200	320	85	25m / 750m	14.90	m
8139115	 7 ⁴ 640344 ⁴ 579195	200	340	85	25m / 750m	14.90	m
8139116	 7 ⁴ 640344 ⁴ 579201	200	360	85	25m / 625m	14.90	m
8139117	 7 ⁴ 640344 ⁴ 579218	200	380	85	25m / 625m	14.90	m
8139118	 7 ⁴ 640344 ⁴ 579225	200	400	85	25m / 625m	14.90	m
8139119	 7 ⁴ 640344 ⁴ 579232	200	420	85	25m / 625m	33.30	m
8139120	 7 ⁴ 640344 ⁴ 579348	200	440	85	25m / 500m	33.30	m
8139121	 7 ⁴ 640344 ⁴ 579379	200	460	85	25m / 500m	33.30	m
8139122	 7 ⁴ 640344 ⁴ 579386	200	480	85	25m / 400m	33.30	m
8139123	 7 ⁴ 640344 ⁴ 579393	200	500	85	25m / 400m	33.30	m
8139124	 7 ⁴ 640344 ⁴ 579409	200	520	85	25m / 400m	38.15	m
8139125	 7 ⁴ 640344 ⁴ 579416	200	540	85	25m / 400m	38.15	m
8139126	 7 ⁴ 640344 ⁴ 579423	200	560	85	25m / 500m	38.15	m
8139127	 7 ⁴ 640344 ⁴ 579430	200	580	85	2.5m / 25m	38.15	m
8139128	 7 ⁴ 640344 ⁴ 579447	200	600	85	2.5m / 25m	38.15	m
8139129	 7 ⁴ 640344 ⁴ 579454	200	620	85	2.5m / 25m	43.20	m

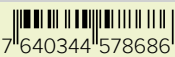
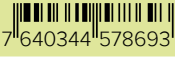
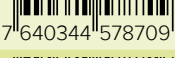
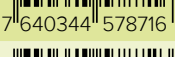
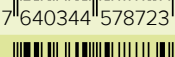
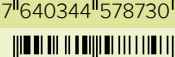
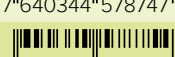
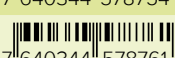
DISTANZKÖRBE
Distanzkörbe mit Fuss

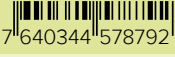
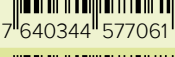
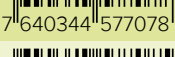
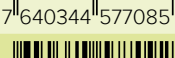
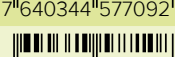
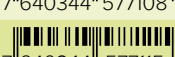
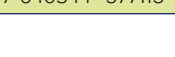
Artikelnummer	EAN Code	Teilung mm	Höhe mm	Breite oben mm	Bund / Werksbund	Preis CHF	ME
8139130	 7 ⁴ 640344 ⁴ 579461	200	640	85	2.5m / 25m	43.20	m
8139131	 7 ⁴ 640344 ⁴ 579706	200	660	85	2.5m / 25m	43.20	m
8139132	 7 ⁴ 640344 ⁴ 579775	200	680	85	2.5m / 25m	43.20	m
8139133	 7 ⁴ 640344 ⁴ 579782	200	700	85	2.5m / 25m	43.20	m
8139134	 7 ⁴ 640344 ⁴ 579799	240	720	85	2.5m / 25m	47.20	m
8139135	 7 ⁴ 640344 ⁴ 579805	240	740	85	2.5m / 25m	47.20	m
8139136	 7 ⁴ 640344 ⁴ 579812	240	760	85	2.5m / 25m	47.20	m
8139137	 7 ⁴ 640344 ⁴ 579829	240	780	85	2.5m / 25m	47.20	m
8139138	 7 ⁴ 640344 ⁴ 579836	240	800	85	2.5m / 25m	47.20	m
8139139	 7 ⁴ 640344 ⁴ 576606	240	820	85	2.5m / 25m	51.00	m
8139140	 7 ⁴ 640344 ⁴ 576613	240	840	85	2.5m / 25m	52.50	m
8139141	 7 ⁴ 640344 ⁴ 576620	240	860	85	2.5m / 25m	51.00	m
8139142	 7 ⁴ 640344 ⁴ 576637	240	880	85	2.5m / 25m	51.00	m
8139143	 7 ⁴ 640344 ⁴ 576644	240	900	85	2.5m / 25m	51.00	m
8139144	 7 ⁴ 640344 ⁴ 576651	240	920	85	2.5m / 25m	57.20	m
8139145	 7 ⁴ 640344 ⁴ 577030	240	940	85	2.5m / 25m	57.20	m
8139146	 7 ⁴ 640344 ⁴ 577054	240	960	85	2.5m / 25m	57.20	m
8139147	 7 ⁴ 640344 ⁴ 578594	240	980	85	2.5m / 25m	57.20	m
8139148	 7 ⁴ 640344 ⁴ 578600	240	1000	85	2.5m / 25m	57.20	m
8139149	 7 ⁴ 640344 ⁴ 578617	240	1020	85	2.5m / 25m	59.00	m
8139150	 7 ⁴ 640344 ⁴ 578624	240	1040	85	2.5m / 25m	59.00	m
8139151	 7 ⁴ 640344 ⁴ 578631	240	1060	85	2.5m / 25m	59.00	m
8139152	 7 ⁴ 640344 ⁴ 578648	240	1080	85	2.5m / 25m	59.00	m
8139153	 7 ⁴ 640344 ⁴ 578655	240	1100	85	2.5m / 25m	59.00	m
8139154	 7 ⁴ 640344 ⁴ 578662	240	1120	85	2.5m / 25m	62.00	m
8139155	 7 ⁴ 640344 ⁴ 578679	240	1140	85	2.5m / 25m	62.00	m

Artikelnummer	EAN Code	Teilung mm	Höhe mm	Breite oben mm	Bund / Werkbund	Preis CHF	ME
8139156	 7 ⁴ 640344 ⁴ 578686	240	1160	85	2.5m / 25m	62.00	m
8139157	 7 ⁴ 640344 ⁴ 578693	240	1180	85	2.5m / 25m	62.00	m
8139158	 7 ⁴ 640344 ⁴ 578709	240	1200	85	2.5m / 25m	62.00	m
8139159	 7 ⁴ 640344 ⁴ 578716	200	1220	85	2.5m / 25m	69.00	m
8139160	 7 ⁴ 640344 ⁴ 578723	200	1240	85	2.5m / 25m	69.00	m
8139161	 7 ⁴ 640344 ⁴ 578730	200	1260	85	2.5m / 25m	69.00	m
8139162	 7 ⁴ 640344 ⁴ 578747	200	1280	85	2.5m / 25m	69.00	m
8139163	 7 ⁴ 640344 ⁴ 578754	200	1300	85	2.5m / 25m	69.00	m
8139164	 7 ⁴ 640344 ⁴ 578761	200	1320	85	2.5m / 25m	76.00	m
8139165	 7 ⁴ 640344 ⁴ 578778	200	1340	85	2.5m / 25m	76.00	m
8139166	 7 ⁴ 640344 ⁴ 578785	200	1360	85	2.5m / 25m	76.00	m
8139167	 7 ⁴ 640344 ⁴ 578792	200	1380	85	2.5m / 25m	76.00	m
8139168	 7 ⁴ 640344 ⁴ 577061	200	1400	85	2.5m / 25m	76.00	m
8139169	 7 ⁴ 640344 ⁴ 577078	200	1420	85	2.5m / 25m	79.00	m
8139170	 7 ⁴ 640344 ⁴ 577085	200	1440	85	2.5m / 25m	79.00	m
8139171	 7 ⁴ 640344 ⁴ 577092	200	1460	85	2.5m / 25m	79.00	m
8139172	 7 ⁴ 640344 ⁴ 577108	200	1480	85	2.5m / 25m	79.00	m
8139173	 7 ⁴ 640344 ⁴ 577115	200	1500	85	2.5m / 25m	79.00	m

DISTANZKÖRBE

Distanzkörbe ohne Fuss

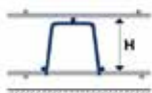

Distanzkörbe ohne Fuss

Distanzkörbe ohne Kunststoff-Füssen können schnell und einfach auf der Baustelle verlegt werden. Die Distanzkörbe sind extrem stabil und massgenau, damit die Betondeckung und der Abstand der statisch relevanten Armierung eingehalten werden kann.









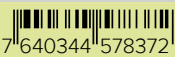
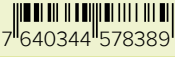
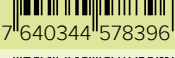
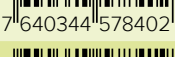
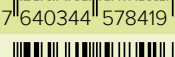
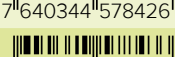

Höhe 60 – 1500 mm

- Stücklänge 2.50 Meter
- 1 Bund entspricht 10 Stk.
- Werkbunde können individuell zusammengestellt werden

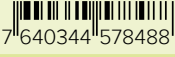
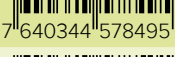
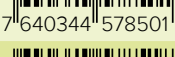
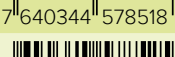
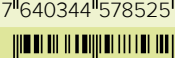
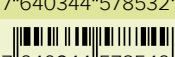



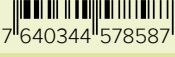
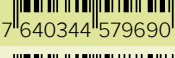
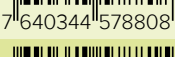
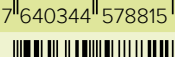
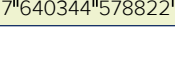





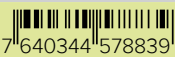
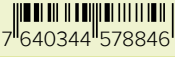
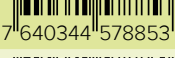
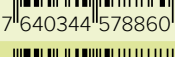
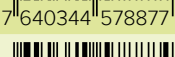
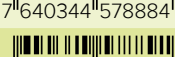
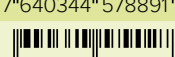

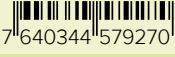
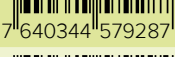
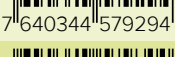
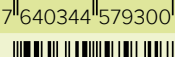
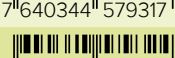
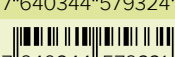

QR-Code klickbar

Artikelnummer	EAN Code	Teilung mm	Höhe mm	Breite oben mm	Bund / Werksbund	Preis CHF	ME
8139174	7 ⁶⁴⁰³⁴⁴ 579591	200	40	85	25m / 500m	16.50	m
8139175	7 ⁶⁴⁰³⁴⁴ 579607	200	50	85	25m / 500m	16.50	m
8139176	7 ⁶⁴⁰³⁴⁴ 579614	200	60	85	25m / 500m	16.50	m
8139177	7 ⁶⁴⁰³⁴⁴ 579621	200	70	85	25m / 1600m	6.45	m
8139178	7 ⁶⁴⁰³⁴⁴ 579638	200	80	85	25m / 1400m	6.45	m
8139179	7 ⁶⁴⁰³⁴⁴ 579645	200	90	85	25m / 1400m	6.45	m
8139180	7 ⁶⁴⁰³⁴⁴ 579652	200	100	85	25m / 1400m	6.45	m
8139181	7 ⁶⁴⁰³⁴⁴ 579669	200	110	85	25m / 1400m	6.95	m
8139182	7 ⁶⁴⁰³⁴⁴ 579676	200	120	85	25m / 1400m	6.95	m
8139183	7 ⁶⁴⁰³⁴⁴ 579683	200	130	85	25m / 1225m	6.95	m
8139184	7 ⁶⁴⁰³⁴⁴ 579003	200	140	85	25m / 1225m	6.95	m
8139185	7 ⁶⁴⁰³⁴⁴ 577122	200	150	85	25m / 1050m	6.95	m
8139186	7 ⁶⁴⁰³⁴⁴ 577139	200	160	85	25m / 1050m	7.60	m
8139187	7 ⁶⁴⁰³⁴⁴ 577146	200	170	85	25m / 1050m	7.60	m
8139188	7 ⁶⁴⁰³⁴⁴ 577436	200	180	85	25m / 1050m	7.60	m
8139189	7 ⁶⁴⁰³⁴⁴ 578334	200	190	85	25m / 1050m	7.60	m
8139190	7 ⁶⁴⁰³⁴⁴ 578341	200	200	85	25m / 1050m	7.60	m
8139191	7 ⁶⁴⁰³⁴⁴ 578358	200	220	85	25m / 875m	11.30	m
8139192	7 ⁶⁴⁰³⁴⁴ 578365	200	240	85	25m / 875m	11.30	m

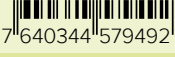
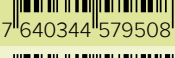
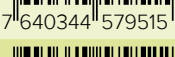
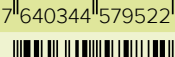
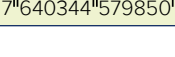
Artikelnummer	EAN Code	Teilung mm	Höhe mm	Breite oben mm	Bund / Werksbund	Preis CHF	ME
8139193	 7 ⁶⁴⁰³⁴⁴ 578372	200	260	85	25m / 875m	11.30	m
8139194	 7 ⁶⁴⁰³⁴⁴ 578389	200	280	85	25m / 875m	11.30	m
8139195	 7 ⁶⁴⁰³⁴⁴ 578396	200	300	85	25m / 875m	11.30	m
8139196	 7 ⁶⁴⁰³⁴⁴ 578402	200	320	85	25m / 625m	14.90	m
8139197	 7 ⁶⁴⁰³⁴⁴ 578419	200	340	85	25m / 625m	14.90	m
8139198	 7 ⁶⁴⁰³⁴⁴ 578426	200	360	85	25m / 500m	14.90	m
8139199	 7 ⁶⁴⁰³⁴⁴ 578433	200	380	85	25m / 500m	14.90	m
8139200	 7 ⁶⁴⁰³⁴⁴ 578440	200	400	85	25m / 500m	14.90	m
8139201	 7 ⁶⁴⁰³⁴⁴ 578457	200	420	85	25m / 500m	33.30	m
8139202	 7 ⁶⁴⁰³⁴⁴ 578464	200	440	85	25m / 500m	33.30	m
8139203	 7 ⁶⁴⁰³⁴⁴ 578471	200	460	85	25m / 500m	33.30	m
8139204	 7 ⁶⁴⁰³⁴⁴ 578488	200	480	85	25m / 500m	33.30	m
8139205	 7 ⁶⁴⁰³⁴⁴ 578495	200	500	85	25m / 400m	33.30	m
8139206	 7 ⁶⁴⁰³⁴⁴ 578501	200	520	85	25m / 400m	38.15	m
8139207	 7 ⁶⁴⁰³⁴⁴ 578518	200	540	85	25m / 400m	38.15	m
8139208	 7 ⁶⁴⁰³⁴⁴ 578525	200	560	85	25m / 500m	38.15	m
8139209	 7 ⁶⁴⁰³⁴⁴ 578532	200	580	85	2.5m / 25m	38.15	m
8139210	 7 ⁶⁴⁰³⁴⁴ 578549	200	600	85	2.5m / 25m	38.15	m
8139211	 7 ⁶⁴⁰³⁴⁴ 578556	200	620	85	2.5m / 25m	43.20	m
8139212	 7 ⁶⁴⁰³⁴⁴ 578563	200	640	85	2.5m / 25m	43.20	m
8139213	 7 ⁶⁴⁰³⁴⁴ 578570	200	660	85	2.5m / 25m	43.20	m
8139214	 7 ⁶⁴⁰³⁴⁴ 578587	200	680	85	2.5m / 25m	43.20	m
8139215	 7 ⁶⁴⁰³⁴⁴ 579690	200	700	85	2.5m / 25m	43.20	m
8139216	 7 ⁶⁴⁰³⁴⁴ 578808	240	720	85	2.5m / 25m	47.20	m
8139217	 7 ⁶⁴⁰³⁴⁴ 578815	240	740	85	2.5m / 25m	47.20	m
8139218	 7 ⁶⁴⁰³⁴⁴ 578822	240	760	85	2.5m / 25m	47.20	m

DISTANZKÖRBE
Distanzkörbe ohne Fuss

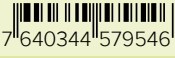
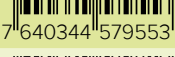
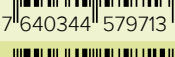
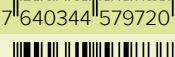
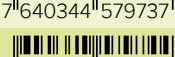
Artikelnummer	EAN Code	Teilung mm	Höhe mm	Breite oben mm	Bund / Werksbund	Preis CHF	ME
8139219	 7 ⁴ 640344 ⁴ 578839 ¹	240	780	85	2.5m / 25m	47.20	m
8139220	 7 ⁴ 640344 ⁴ 578846 ¹	240	800	85	2.5m / 25m	47.20	m
8139221	 7 ⁴ 640344 ⁴ 578853 ¹	240	820	85	2.5m / 25m	51.00	m
8139222	 7 ⁴ 640344 ⁴ 578860 ¹	240	840	85	2.5m / 25m	51.00	m
8139223	 7 ⁴ 640344 ⁴ 578877 ¹	240	860	85	2.5m / 25m	51.00	m
8139224	 7 ⁴ 640344 ⁴ 578884 ¹	240	880	85	2.5m / 25m	51.00	m
8139225	 7 ⁴ 640344 ⁴ 578891 ¹	240	900	85	2.5m / 25m	51.00	m
8139226	 7 ⁴ 640344 ⁴ 579027 ¹	240	920	85	2.5m / 25m	57.20	m
8139227	 7 ⁴ 640344 ⁴ 579249 ¹	240	940	85	2.5m / 25m	57.20	m
8139228	 7 ⁴ 640344 ⁴ 579256 ¹	240	960	85	2.5m / 25m	57.20	m
8139229	 7 ⁴ 640344 ⁴ 579263 ¹	240	980	85	2.5m / 25m	57.20	m
8139230	 7 ⁴ 640344 ⁴ 579270 ¹	240	1000	85	2.5m / 25m	57.20	m
8139231	 7 ⁴ 640344 ⁴ 579287 ¹	240	1020	85	2.5m / 25m	59.00	m
8139232	 7 ⁴ 640344 ⁴ 579294 ¹	240	1040	85	2.5m / 25m	59.00	m
8139233	 7 ⁴ 640344 ⁴ 579300 ¹	240	1060	85	2.5m / 25m	59.00	m
8139234	 7 ⁴ 640344 ⁴ 579317 ¹	240	1080	85	2.5m / 25m	59.00	m
8139235	 7 ⁴ 640344 ⁴ 579324 ¹	240	1100	85	2.5m / 25m	59.00	m
8139236	 7 ⁴ 640344 ⁴ 579331 ¹	240	1120	85	2.5m / 25m	62.00	m
8139237	 7 ⁴ 640344 ⁴ 579355 ¹	240	1140	85	2.5m / 25m	62.00	m
8139238	 7 ⁴ 640344 ⁴ 579478 ¹	240	1160	85	2.5m / 25m	62.00	m
8139239	 7 ⁴ 640344 ⁴ 579485 ¹	240	1180	85	2.5m / 25m	62.00	m
8139240	 7 ⁴ 640344 ⁴ 579492 ¹	240	1200	85	2.5m / 25m	62.00	m
8139241	 7 ⁴ 640344 ⁴ 579508 ¹	200	1220	85	2.5m / 25m	69.00	m
8139242	 7 ⁴ 640344 ⁴ 579515 ¹	200	1240	85	2.5m / 25m	69.00	m
8139243	 7 ⁴ 640344 ⁴ 579522 ¹	200	1260	85	2.5m / 25m	69.00	m
8139244	 7 ⁴ 640344 ⁴ 579850 ¹	200	1280	85	2.5m / 25m	69.00	m

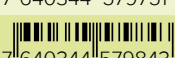
Artikelnummer	EAN Code	Teilung mm	Höhe mm	Breite oben mm	Bund / Werksbund	Preis CHF	ME
<u>8139245</u>	 7 ⁴ 640344 ⁴ 579539	200	1300	85	2.5m / 25m	69.00	m
<u>8139246</u>	 7 ⁴ 640344 ⁴ 579546	200	1320	85	2.5m / 25m	76.00	m
<u>8139247</u>	 7 ⁴ 640344 ⁴ 579553	200	1340	85	2.5m / 25m	76.00	m
<u>8139248</u>	 7 ⁴ 640344 ⁴ 579713	200	1360	85	2.5m / 25m	76.00	m
<u>8139249</u>	 7 ⁴ 640344 ⁴ 579720	200	1380	85	2.5m / 25m	76.00	m
<u>8139250</u>	 7 ⁴ 640344 ⁴ 579737	200	1400	85	2.5m / 25m	76.00	m
<u>8139251</u>	 7 ⁴ 640344 ⁴ 579744	200	1420	85	2.5m / 25m	79.00	m
<u>8139252</u>	 7 ⁴ 640344 ⁴ 579751	200	1440	85	2.5m / 25m	79.00	m
<u>8139253</u>	 7 ⁴ 640344 ⁴ 579843	200	1460	85	2.5m / 25m	79.00	m
<u>8139254</u>	 7 ⁴ 640344 ⁴ 576576	200	1480	85	2.5m / 25m	79.00	m
<u>8139255</u>	 7 ⁴ 640344 ⁴ 576583	200	1500	85	2.5m / 25m	79.00	m

BEWEHRUNGSTECHNIK



Rückbiegeanschluss 20



Einzelschubdorne 27

BE-BOX® Standard einschnittig

- Haken-Typen einschnittig / V-Typen
- Verankerungslängen gemäs SIA 262:2013
- Längen: Standard 1.25 m und 0.80 m (Zusatz a)
- Einfaches Ausschalen dank Reissverschluss Systemabdeckung aus Kunststoff
- Erläuterung Typenbezeichnung: z.Bsp.: V10-15 h15 lü50
(Stahl Ø - Teilung e - Bügelhöhe h - Verankerungslänge lü)



QR-Code klickbar



Artikelnummer	EAN Code	Länge cm	Typ	Gewicht / m	Preis CHF	ME
8139645	7 ⁶⁴⁰³⁴⁴ 571861	125	Pos. 1 V10-15 h15 lü50	3.6	33.20	m
8139646	7 ⁶⁴⁰³⁴⁴ 571878	80	Pos 1a V10-15 h15 lü50	3.6	36.50	m
8139647	7 ⁶⁴⁰³⁴⁴ 571885	125	Pos. 2 V12-15 h15 lü60	5.6	47.80	m
8139648	7 ⁶⁴⁰³⁴⁴ 571892	80	Pos. 2a V12-15 h15 lü60	5.6	52.50	m
8139649	7 ⁶⁴⁰³⁴⁴ 578099	125	Pos. 3 V12-15 h20 lü60	5.969	49.50	m
8139650	7 ⁶⁴⁰³⁴⁴ 578105	80	Pos. 3a V12-15 h20 lü60	5.419	54.50	m
8139651	7 ⁶⁴⁰³⁴⁴ 578112	125	Pos. 4 V12-15 h25 lü60	6.238	50.70	m
8139652	7 ⁶⁴⁰³⁴⁴ 578129	80	Pos. 4a V12-15 h25 lü60	5.682	55.80	m
8139726	7 ⁶⁴⁰³⁴⁴ 578068	125	Pos. 29 V08-20 h15 lü40	1.579	22.50	m
8139737	7 ⁶⁴⁰³⁴⁴ 578051	125	Pos. 38 V08-15 h15 lü40	1.969	28.30	m
8139744	7 ⁶⁴⁰³⁴⁴ 578075	125	Pos. 42 V10-15 h20 lü50	3.648	41.90	m
8139745	7 ⁶⁴⁰³⁴⁴ 578082	125	Pos. 43 V10-15 h25 lü50	3.837	41.70	m



BE-BOX® Standard zweischnittig

- Zweireihiger Anschluss / B-Typen
- Verankerungslängen gemäss SIA 262:2013
- Längen: Standard 1.25 m und 0.80 m (Zusatz a)
- Einfaches Ausschalen dank Reissverschluss Systemabdeckung aus Kunststoff
- Erläuterung Typenbezeichnung: z.Bsp.: B09-10-15 h12 lü40
- (Bügelbreite b - Stahl Ø - Teilung e - Bügelhöhe h - Verankerungslänge lü)











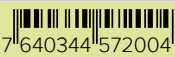
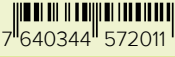
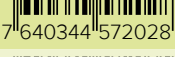
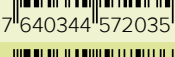
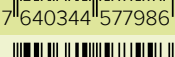
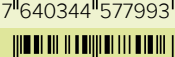

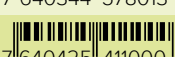

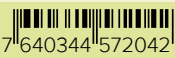
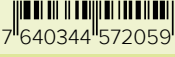
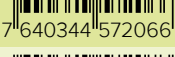
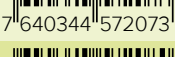
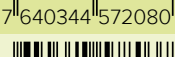
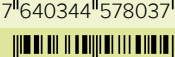
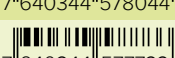



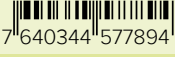
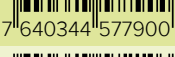
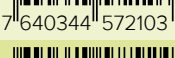
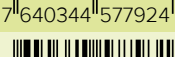
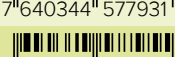
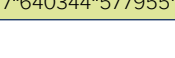



QR-Code Klickbar

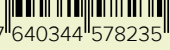
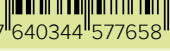
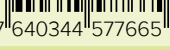
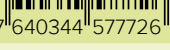
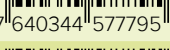
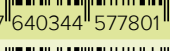
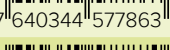
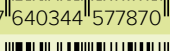
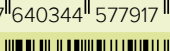
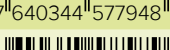
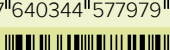
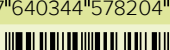
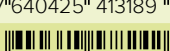
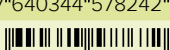
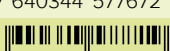
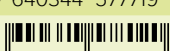
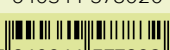
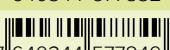



Artikelnummer	EAN Code	Länge cm	Typ	Gewicht / m	Preis CHF	ME
8139653	7 640344 571908	125	Pos. 5 B09-10-15 h12 lü40	5.1	51.40	m
8139654	7 640344 577689	80	Pos. 5a B09-10-15 h12 lü40	4.803	56.50	m
8139655	7 640344 577696	125	Pos. 6 B09-10-15 h15 lü40	5.141	52.60	m
8139656	7 640344 577702	80	Pos. 6a B09-10-15 h15 lü40	5.141	57.90	m
8139657	7 640344 577764	125	Pos. 7 B12-10-15 h12 lü50	5.858	50.70	m
8139658	7 640344 577771	80	Pos. 7a B12-10-15 h12 lü50	5.583	55.80	m
8139660	7 640344 571915	125	Pos. 8 B12-10-15 h15 lü50	6.5	53.30	m
8139661	7 640344 571922	80	Pos. 8a B12-10-15 h15 lü50	6.5	56.80	m
8139662	7 640344 577788	125	Pos. 9 B12-10-15 h20 lü50	6.464	48.00	m
8139663	7 640425 410980	80	Pos. 9a B12-10-15 h20 lü50	6.175	52.80	m
8139664	7 640344 577818	125	Pos. 10 B12-10-15 h25 lü50	6.843	65.30	m
8139665	7 640344 577825	80	Pos. 10a B12-10-15 h25 lü50	6.545	71.90	m
8139666	7 640344 571939	125	Pos. 11 B12-12-15 h15 lü50	9	70.10	m
8139667	7 640344 571946	80	Post. 11a B12-12-15 h15 lü50	9	77.10	m
8139676	7 640344 571953	125	Pos. 12 B14-10-15 h15 lü50	6.7	57.90	m
8139677	7 640344 571960	80	Pos. 12a B14-10-15 h15 lü50	6.7	63.70	m
8139698	7 640344 571977	125	Pos. 13 B14-12-15 h15 lü60	10.2	75.80	m
8139699	7 640344 571984	80	Pos. 13a B14-12-15 h15 lü60	10.2	83.40	m
8139700	7 640344 571991	125	Pos. 14 B17-10-15 h15 lü50	6.9	59.20	m

BEWEHRUNGSTECHNIK
Rückbiegeanschluss

Artikelnummer	EAN Code	Länge cm	Typ	Gewicht / m	Preis CHF	ME
8139701	 7 ^h 640344 ^h 572004 ^h	80	Pos. 14a B17-10-15 h15 lü50	6.9	65.00	m
8139702	 7 ^h 640344 ^h 572011 ^h	125	Pos. 15 B17-12-15 h15 lü60	10.6	77.30	m
8139703	 7 ^h 640344 ^h 572028 ^h	80	Pos. 15a B17-12-15 h15 lü60	10.6	85.10	m
8139704	 7 ^h 640344 ^h 572035 ^h	125	Pos. 16 B17-12-15 h20 lü60	11.2	80.90	m
8139705	 7 ^h 640344 ^h 577986 ^h	125	Pos. 16a B17-12-15 h20 lü60	9.216	89.10	m
8139706	 7 ^h 640344 ^h 577993 ^h	125	Pos. 17 B17-12-15 h25 lü60	10.844	89.30	m
8139707	 7 ^h 640344 ^h 578006 ^h	125	Pos. 18 B18-10-15 h15 lü50	6.676	61.70	m
8139708	 7 ^h 640344 ^h 578013 ^h	80	Pos. 18a B18-10-15 h15 lü50	6.41	67.90	m
8139709	 7 ^h 640425 ^h 411000 ^h	125	Pos. 19 B18-12-15 h15 lü60	10.14	79.80	m
8139710	 7 ^h 640425 ^h 411017 ^h	80	Pos. 19a B18-12-15 h15 lü60	8.69	91.90	m
8139711	 7 ^h 640344 ^h 572042 ^h	125	Pos. 20 B20-10-15 h15 lü50	7.2	62.90	m
8139712	 7 ^h 640344 ^h 572059 ^h	80	Pos. 20a B20-10-15 h15 lü50	7.2	69.20	m
8139713	 7 ^h 640344 ^h 572066 ^h	125	Pos. 21 B20-12-15 h15 lü60	10.9	81.60	m
8139714	 7 ^h 640344 ^h 572073 ^h	80	Pos. 21a B20-12-15 h15 lü50	10.9	89.70	m
8139715	 7 ^h 640344 ^h 572080 ^h	125	Pos. 22 B20-12-15 h20 lü60	12	85.00	m
8139716	 7 ^h 640344 ^h 578037 ^h	125	Pos. 23 B20-12-15 h25 lü60	11.241	93.80	m
8139717	 7 ^h 640344 ^h 578044 ^h	80	Pos. 23a B20-12-15 h25 lü60	10.148	103.20	m
8139720	 7 ^h 640344 ^h 577733 ^h	125	Pos. 25 B12-08-20 h15 lü40	3.76	34.70	m
8139721	 7 ^h 640344 ^h 577740 ^h	125	Pos. 26 B12-10-20 h15 lü50	4.789	43.00	m
8139722	 7 ^h 640344 ^h 577757 ^h	80	Pos. 26a B12-10-20 h15 lü50	4.94	51.90	m
8139723	 7 ^h 640344 ^h 577887 ^h	125	Pos. 27 B17-08-20 h15 lü40	3.288	37.10	m
8139724	 7 ^h 640344 ^h 577894 ^h	125	Pos. 28 B17-10-20 h15 lü50	5.131	41.50	m
8139725	 7 ^h 640344 ^h 577900 ^h	80	Pos. 28a B17-10-20 h15 lü50	5.299	55.60	m
8139727	 7 ^h 640344 ^h 572103 ^h	125	Pos. 30 B12-12-15 h20 lü50	10.1	61.20	m
8139728	 7 ^h 640344 ^h 577924 ^h	125	Pos. 31 B12-12-15 h25 lü50	9.297	76.60	m
8139729	 7 ^h 640344 ^h 577931 ^h	125	Pos. 32 B17-10-15 h20 lü50	7.036	61.80	m
8139730	 7 ^h 640344 ^h 577955 ^h	125	Pos. 33 B17-10-15 h25 lü50	7.232	65.30	m

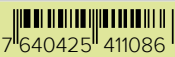
Artikelnummer	EAN Code	Länge cm	Typ	Gewicht / m	Preis CHF	ME
8139731	 7 ⁶⁴⁰³⁴⁴ 577962	125	Pos. 33a B17-10-15 h25 lü50	6.94	71.90	m
8139732	 7 ⁶⁴⁰³⁴⁴ 578211	125	Pos. 34 B20-10-15 h20 lü50	7.203	65.40	m
8139733	 7 ⁶⁴⁰³⁴⁴ 578235	125	Pos. 35 B20-10-15 h25 lü50	7.581	69.50	m
8139734	 7 ⁶⁴⁰³⁴⁴ 577658	125	Pos. 36 B06-08-15 h12 lü40	3.175	42.40	m
8139735	 7 ⁶⁴⁰³⁴⁴ 577665	80	Pos. 36a B06-08-15 h12 lü40	3	46.60	m
8139736	 7 ⁶⁴⁰³⁴⁴ 577726	125	Pos. 37 B12-08-15 h15 lü40	3.715	44.90	m
8139746	 7 ⁶⁴⁰³⁴⁴ 577795	125	Pos. 44 B12-10-15 h15 lü60	6.843	69.70	m
8139747	 7 ⁶⁴⁰³⁴⁴ 577801	125	Pos. 45 B12-10-15 h20 lü60	7.222	73.90	m
8139748	 7 ⁶⁴⁰³⁴⁴ 577863	125	Pos. 46 B14-12-15 h20 lü60	9.487	96.00	m
8139749	 7 ⁶⁴⁰³⁴⁴ 577870	125	Pos. 47 B14-12-15 h25 lü60	10.564	98.90	m
8139750	 7 ⁶⁴⁰³⁴⁴ 577917	125	Pos. 48 B17-10-15 h15 lü60	7.232	50.20	m
8139751	 7 ⁶⁴⁰³⁴⁴ 577948	125	Pos. 49 B17-10-15 h20 lü60	7.611	78.00	m
8139752	 7 ⁶⁴⁰³⁴⁴ 577979	125	Pos. 50 B17-12-15 h15 lü60	11.5	64.00	m
8139753	 7 ⁶⁴⁰³⁴⁴ 578204	125	Pos. 51 B20-10-20 h15 lü50	5.509	62.90	m
8139754	 7 ⁶⁴⁰⁴²⁵ 413189	80	Pos. 51a B20-10-20 h15 lü50	5.636	69.10	m
8139755	 7 ⁶⁴⁰³⁴⁴ 578242	125	Pos. 52 B20-12-15 h15 lü60	10.163	110.60	m
8139756	 7 ⁶⁴⁰³⁴⁴ 577672	125	Pos. 53 B09-08-15 h15 lü40	3.576	48.40	m
8139757	 7 ⁶⁴⁰³⁴⁴ 577719	125	Pos. 54 B09-10-15 h15 lü50	5.9	61.30	m
8139758	 7 ⁶⁴⁰³⁴⁴ 578020	125	Pos. 55 B18-10-15 h25 lü50	7.433	72.40	m
8139759	 7 ⁶⁴⁰³⁴⁴ 577832	125	Pos. 56 B12-12-15 h15 lü60	9.297	81.30	m
8139760	 7 ⁶⁴⁰³⁴⁴ 577849	125	Pos. 57 B12-12-15 h20 lü60	9.836	91.30	m
8139777	 7 ⁶⁴⁰³⁴⁴ 578136	125	Pos. 61 E12-15 h25 lü60 v20	6.13	65.20	m
8139782	 7 ⁶⁴⁰⁴²⁵ 411147	125	Pos. 73 B14-10-15 h20 lü50	6.622	71.50	m
8139783	 7 ⁶⁴⁰⁴²⁵ 411154	125	Pos. 74 B14-10-15 h25 lü50	7.001	74.50	m
8139784	 7 ⁶⁴⁰⁴²⁵ 411062	125	Pos. 83 B14-14-15 h20 lü50	12.443	170.74	m
8139787	 7 ⁶⁴⁰⁴²⁵ 413202	80	Pos. 83a B14-14-15 h20 lü50	11.811	180.40	m
8139788	 7 ⁶⁴⁰⁴²⁵ 411079	125	Pos. 85 B17-14-15 h20 lü60	14.363	198.20	m

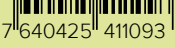



Artikelnummer	EAN Code	Länge cm	Typ	Gewicht / m	Preis CHF	ME
8139789		125	Pos. 87 B20-14-15 h20 lü62	15.11	222.78	m
8139790		125	Pos. 87a B20-14-15 h20 lü62	13.249	217.90	m
8139791		125	Pos. 88 B20-14-15 h25 lü62	15.569	250.70	m

BE-BOX® Standard Konsole

- Konsolelemente
- Verankerungslängen gemäs SIA 262:2013
- Längen: Standard 1.25 m und 0.80 m (Zusatz a)
- Einfaches Ausschalen dank Reissverschluss Systemabdeckung aus Kunststoff
- Erläuterung Typenbezeichnung: z.Bsp.: K12-10-20 h15 lü18
(Bügelbreite b - Stahl Ø - Teilung e - Bügelhöhe h - Verankerungslänge lü)

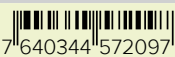

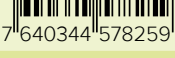
QR-Code klickbar

Artikelnummer	EAN Code	Länge cm	Typ	Gewicht / m	Preis CHF	ME
8139718		125	Pos. 24 K12-10-20 h15 lü18	3.8	47.50	m
8139719		80	Pos. 24a K12-10-20 h15 lü18	3.8	49.30	m
8139792		125	Pos. 90 K12-10-15 h15 lü 18	4.472	71.90	m
8139793		80	Pos. 90a K12-10-15 h15 lü 18	4.451	78.50	m

BE-BOX® Standard Doppelkasten

- Zweireihiger Anschluss mit Doppelkasten
- D-Typen geeignet für die Montage von Abdichtungssystemen
- Verankerungslängen gemäs SIA 262:2013
- Längen: Standard 1.25 m und 0.80 m (Zusatz a)
- Einfaches Ausschalen dank Reissverschluss Systemabdeckung aus Kunststoff
- Erläuterung Typenbezeichnung: z.Bsp.: D17-10-15 h15 lü45
 (Bügelbreite b - Stahl Ø - Teilung e - Bügelhöhe h - Verankerungslänge lü)



QR-Code klickbar



Artikelnummer	EAN Code	Länge cm	Typ	Gewicht / m	Preis CHF	ME
8139738	7 ⁶⁴⁰³⁴⁴ 572110	125	Pos. 39 D17-10-15 h15 lü45	6.041	68.00	m
8139739	7 ⁶⁴⁰³⁴⁴ 578143	80	Pos. 39a D17-10-15 h15 lü45	5.861	74.00	m
8139740	7 ⁶⁴⁰³⁴⁴ 578150	125	Pos. 40 D20-12-15 h15 lü60	10.105	95.00	m
8139741	7 ⁶⁴⁰³⁴⁴ 578167	80	Pos. 40a D20-12-15 h15 lü60	9.048	105.00	m
8139742	7 ⁶⁴⁰³⁴⁴ 578174	125	Pos. 41 D22-12-15 h15 lü60	10.213	99.00	m
8139743	7 ⁶⁴⁰³⁴⁴ 578181	80	Pos. 41a D22-12-15 h15 lü60	9.153	110.00	m
8139775	7 ⁶⁴⁰³⁴⁴ 578228	125	Pos. 60 D22-10-15 h25 lü60	8.125	82.00	m
8139776	7 ⁶⁴⁰⁴²⁵ 413196	80	Pos. 60a D22-10-15 h25 lü60	7.378	88.00	m
8139778	7 ⁶⁴⁰³⁴⁴ 578198	125	Pos. 62 D22-10-15 h15 lü50	6.61	78.00	m
8139779	7 ⁶⁴⁰³⁴⁴ 578280	125	Pos. 63 D17-12-15 h15 lü60	9.943	90.00	m
9089634	7 ⁶⁴⁰⁴²⁵ 414179	80	Pos. 63a D17-12-15 h15 lü60	9.943	90.00	m
8139780	7 ⁶⁴⁰³⁴⁴ 578273	125	Pos. 64 D22-12-15 h25 lü60	11.29	115.00	m
8139781	7 ⁶⁴⁰³⁴⁴ 578266	125	Pos. 65 D22-12-15 h20 lü 60	10.752	112.00	m

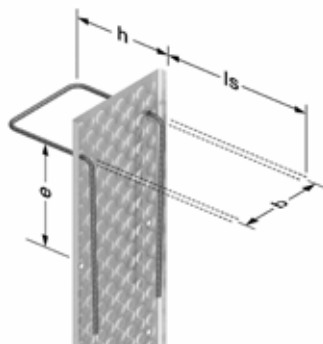







BE-BOX® Quer + Längs Verzahnung

- Längs- und Querverzahrter Rückbiegeanschluss
- Nur ein Anschluss nötig für Quer- oder Längsverzahnung
- Keine Verwechslung mehr möglich
- Zweireihiger Anschluss / B-Typen
- Verankerungslängen gemäss SIA 262:2013
- Längen: Standard 1.25 m
- Erläuterung Typenbezeichnung: z.Bsp.: B09-10-15 h15 lü50
- (Bügelbreite b - Stahl-Ø - Teilung e - Bügelhöhe h - Verankerungslänge lü)

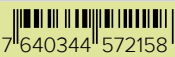

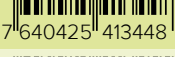
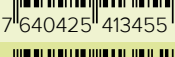
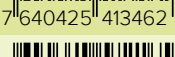
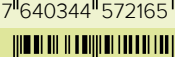
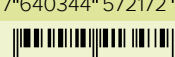
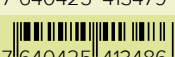
QR-Code klickbar

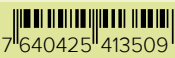
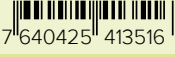
Artikelnummer	EAN Code	Länge cm	Typ	Gewicht / m	Preis CHF	ME
8149008	7 640425 413325	125	Pos. Q / L 112 I B09-10-15 h15 lü 50	6.95	75.50	m
8149007	7 640425 413332	125	Pos. Q / L 113 I B09-10-20 h15 lü 50	5.6	64.70	m
8148929	7 640344 572127	125	Pos. Q / L 142 I B14-10-15 h15 lü 50	7.15	80.40	m
8149009	7 640425 413349	125	Position Q / L 143 I B11-10-20 h15 lü 50	5.8	68.60	m
8148930	7 640344 572134	125	Position Q / L 146 I B11-12-15 h15 lü 60	10.9	103.90	m
8149010	7 640425 413356	125	Position Q / L 147 I B11-12-20 h15 lü 60	8.60	86.30	m
8149011	7 640425 413363	125	Position Q / L 162 I B14-10-15 h15 lü 50	7.5	83.30	m
8149012	7 640425 413370	125	Position Q / L 163 I B14-10-20 h15 lü 50	6.15	70.60	m
8149014	7 640425 413387	125	Position Q / L 165 I B14-12-15 h20 lü 60	11.95	111.80	m
8149013	7 640425 413394	125	Position Q / L 166 I B14-12-15 h15 lü 60	11.35	106.90	m
8149016	7 640425 413530	125	Position Q / L 167 I B14-12-20 h15 lü 60	9.02	89.20	m
8149015	7 640425 413400	125	Position Q / L 168 I B14-12-15 h25 lü 60	12.45	113.70	m
8148931	7 640344 572141	125	Position Q / L 192 I B16-10-15 h15 lü 50	7.7	85.30	m
8149018	7 640425 413417	125	Position Q / L 193 I B16-10-20 h15 lü 50	6.3	72.60	m
8149017	7 640425 413424	125	Position Q / L 194 I B16-10-15 h25 lü 50	9.7	89.20	m

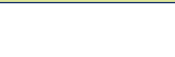
Artikelnummer	EAN Code	Länge cm	Typ	Gewicht / m	Preis CHF	ME
8148932	 7 ⁶⁴⁰³⁴⁴ 572158	125	Pos. Q / L 196 B16-12-15 h15 lü 60	11.6	106.90	m
8149021	 7 ⁶⁴⁰⁴²⁵ 413431	125	Pos. Q / L 197 B16-12-20 h15 lü 60	9.25	91.20	m
8149020	 7 ⁶⁴⁰⁴²⁵ 413448	125	Pos. Q / L 198 B16-12-15 h25 lü 60	12.70	117.60	m
8149019	 7 ⁶⁴⁰⁴²⁵ 413455	125	Pos. Q / L 199 B16-12-15 h20 lü 60	12.1	113.70	m
8149022	 7 ⁶⁴⁰⁴²⁵ 413462	125	Pos. Q / L 241 B21-10-15 h25 lü 50	9.9	99.90	m
8148933	 7 ⁶⁴⁰³⁴⁴ 572165	125	Pos. Q / L 242 B21-10-15 h15 lü 50	8.1	89.20	m
8148934	 7 ⁶⁴⁰³⁴⁴ 572172	125	Pos. Q / L 243 B21-12-15 h15 lü 60	12.05	113.70	m
8149024	 7 ⁶⁴⁰⁴²⁵ 413479	125	Pos. Q / L 244 B21-12-15 h20 lü 60	10.62	118.60	m
8149023	 7 ⁶⁴⁰⁴²⁵ 413486	125	Pos. Q / L 245 B21-10-20 h15 lü 50	7.75	77.70	m
8149025	 7 ⁶⁴⁰⁴²⁵ 413493	125	Pos. Q / L 246 B21-12-15 h25 lü 60	13.1	122.50	m
8149026	 7 ⁶⁴⁰⁴²⁵ 413509	125	Pos. Q / L 247 B21-12-20 h15 lü 60	10.85	100.60	m
8149027	 7 ⁶⁴⁰⁴²⁵ 413516	125	Pos. Q / L 120 K11-10-15 h 15 lü 15	5.5	117.70	m
8149028	 7 ⁶⁴⁰⁴²⁵ 413523	125	Pos. Q / L 121 K16-10-15 h 22 lü 15 v 45	7.55	140.70	m

Einzelshubdorn in 1.4462

- Einzelshubdorn zur Querkraftübertragung im Bereich von Dehnfugen
- Durchmesser in 20 / 22 / 25 / 30 / 35mm
- Hochwertiger Edelstahl in 1.4462
- Hohe mechanische Eigenschaften
- Korrosionswiderstandsklasse IV



QR-Code klickbar

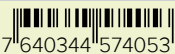

Artikelnummer	EAN Code	Länge mm	ø mm	Preis CHF	ME
8139468	 7 ⁶⁴⁰³⁴⁴ 574053	250	20	11.20	Stk

BEWEHRUNGSTECHNIK
Einzelstabdorne

Artikelnummer	EAN Code	Länge mm	ø mm	Preis CHF	ME
8139469	7 640344 574060	300	20	13.40	Stk
8139470	7 640344 574077	350	20	15.10	Stk
8139471	7 640344 574084	400	20	16.90	Stk
8139472	7 640344 574091	500	20	21.60	Stk
8139473	7 640344 574107	600	20	26.30	Stk
8139474	7 640344 574114	300	22	19.00	Stk
8139475	7 640344 574121	350	22	22.00	Stk
8139476	7 640344 574138	400	22	25.00	Stk
8139477	7 640344 574145	500	22	31.00	Stk
8139478	7 640344 574152	300	25	22.50	Stk
8139479	7 640344 574169	350	25	26.00	Stk
8139480	7 640344 574176	400	25	28.50	Stk
8139481	7 640344 574183	500	25	37.50	Stk
8139482	7 640344 574190	300	30	38.00	Stk
8139483	7 640344 574206	350	30	42.00	Stk
8139484	7 640344 574213	400	30	47.00	Stk
8139485	7 640344 574220	500	30	59.00	Stk
8139486	7 640344 574237	350	35	56.50	Stk
8139487	7 640344 574244	400	35	61.00	Stk
8139488	7 640344 574251	470	35	69.00	Stk

Einzelschubdorn in 1.7227 roh



- Einzelschubdorn zur Querkraftübertragung im Bereich von Dehnfugen
- Hochfester Stahl (roh) / 1.7227
- Hohe mechanische Eigenschaften
- Durchmesser 20mm

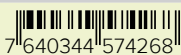
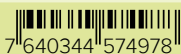
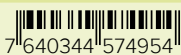
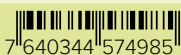

QR-Code klickbar

Artikelnummer	EAN Code	Länge mm	ø mm	Preis CHF	ME
8139489	 7 ⁶⁴⁰³⁴⁴ 574268	300	20	5.00	Stk
8139556	 7 ⁶⁴⁰³⁴⁴ 574978	350	20	5.80	Stk
8139555	 7 ⁶⁴⁰³⁴⁴ 574954	400	20	6.60	Stk
8139557	 7 ⁶⁴⁰³⁴⁴ 574985	500	20	7.70	Stk



Einzelschubdorn in 1.7227 verzinkt



- Einzelschubdorn zur Querkraftübertragung im Bereich von Dehnfugen
- Durchmesser in 20 / 22 / 30 / 35mm
- Hochfester Stahl in 1.7227 verzinkt
- Hohe mechanische Eigenschaften
- Verzinkte Ausführung



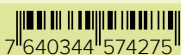

QR-Code klickbar

Artikelnummer	EAN Code	Länge mm	ø mm	Preis CHF	ME
8139562	 7 ⁶⁴⁰³⁴⁴ 575050	200	20	5.50	Stk
8139490	 7 ⁶⁴⁰³⁴⁴ 574275	250	20	6.30	Stk
8139491	 7 ⁶⁴⁰³⁴⁴ 574282	300	20	7.30	Stk

BEWEHRUNGSTECHNIK

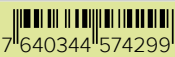
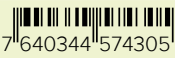
Einzel Schubdorne

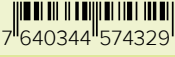
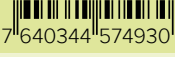
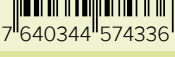
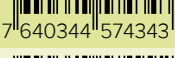
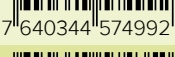
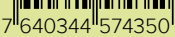
Artikelnummer	EAN Code	Länge mm	ø mm	Preis CHF	ME
8139492	 7 ⁶⁴⁰³⁴⁴ 574299	350	20	7.90	Stk
8139493	 7 ⁶⁴⁰³⁴⁴ 574305	400	20	8.50	Stk
8139494	 7 ⁶⁴⁰³⁴⁴ 574312	500	20	10.10	Stk
8139495	 7 ⁶⁴⁰³⁴⁴ 574329	300	22	9.80	Stk
8139553	 7 ⁶⁴⁰³⁴⁴ 574930	350	22	11.10	Stk
8139496	 7 ⁶⁴⁰³⁴⁴ 574336	300	30	17.70	Stk
8139497	 7 ⁶⁴⁰³⁴⁴ 574343	350	30	19.00	Stk
8139558	 7 ⁶⁴⁰³⁴⁴ 574992	300	35	24.00	Stk
8139498	 7 ⁶⁴⁰³⁴⁴ 574350	350	35	25.00	Stk







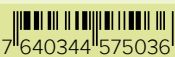
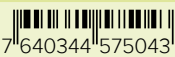

Einzel Schubdorn in 1.4362

- Einzel Schubdorn zur Querkraftübertragung im Bereich von Dehnfugen
- Durchmesser in 16 / 20 mm
- Hochwertiger Edelstahl in 1.4362
- Hohe mechanische Eigenschaften
- Korrosionswiderstandsklasse III

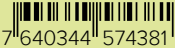

QR-Code klickbar

Artikelnummer	EAN Code	Länge mm	ø mm	Preis CHF	ME
8139563	 7 ⁶⁴⁰³⁴⁴ 575067	170	16	4.40	Stk
8139560	 7 ⁶⁴⁰³⁴⁴ 575036	170	20	9.90	Stk
8139561	 7 ⁶⁴⁰³⁴⁴ 575043	200	20	10.50	Stk
8139499	 7 ⁶⁴⁰³⁴⁴ 574367	250	20	11.10	Stk
8139500	 7 ⁶⁴⁰³⁴⁴ 574374	300	20	12.70	Stk
8139501	 7 ⁶⁴⁰³⁴⁴ 574381	350	20	14.30	Stk

Artikelnummer	EAN Code	Länge mm	ø mm	Preis CHF	ME
8139502	 7 ⁶⁴⁰³⁴⁴ 574398	400	20	16.10	Stk
8139503	 7 ⁶⁴⁰³⁴⁴ 574404	500	20	20.50	Stk
8139504	 7 ⁶⁴⁰³⁴⁴ 574411	600	20	25.00	Stk











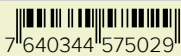



Kunststoff-Gleithülse

- Kunststoffgleithülse für Einzelschubdorne
- Für Durchmesser 16 / 20 / 22 / 25 / 30 / 35 mm
- Aus hochwertigem Duraplast hergestellt
- Nagelplatte und Federelement integriert











QR-Code klickbar

Artikelnummer	EAN Code	für Schubdorn-Länge mm	ø mm	Preis CHF	ME
8139559	 7 ⁶⁴⁰³⁴⁴ 575029	150	16	2.00	Stk
8139507	 7 ⁶⁴⁰³⁴⁴ 574466	250	20	2.30	Stk
8139508	 7 ⁶⁴⁰³⁴⁴ 574473	300	20	2.30	Stk
8139509	 7 ⁶⁴⁰³⁴⁴ 574480	350	20	2.40	Stk
8139510	 7 ⁶⁴⁰³⁴⁴ 574497	400	20	2.40	Stk
8139511	 7 ⁶⁴⁰³⁴⁴ 574503	500	20	2.50	Stk
8139512	 7 ⁶⁴⁰³⁴⁴ 574510	600	20	2.60	Stk
8139513	 7 ⁶⁴⁰³⁴⁴ 574527	300	22	2.40	Stk
8139514	 7 ⁶⁴⁰³⁴⁴ 574534	350	22	2.50	Stk
8139515	 7 ⁶⁴⁰³⁴⁴ 574541	400	22	2.60	Stk
8139516	 7 ⁶⁴⁰³⁴⁴ 574558	450	22	2.65	Stk
8139520	 7 ⁶⁴⁰³⁴⁴ 574596	300	25	3.10	Stk

BEWEHRUNGSTECHNIK

Einzel Schubdorne

Artikelnummer	EAN Code	für Schubdorn-Länge mm	ø mm	Preis CHF	ME
8139521	 7 640344 574602	500	25	3.40	Stk
8139517	 7 640344 574565	250	28	2.70	Stk
8139518	 7 640344 574572	300	30	3.90	Stk
8139519	 7 640344 574589	350	30	4.00	Stk
8139554	 7 640344 574947	400	30	4.10	Stk
8139522	 7 640344 574619	350	35	4.70	Stk
8139523	 7 640344 574626	400	35	4.80	Stk
8139524	 7 640344 574633	470	35	4.90	Stk











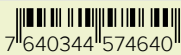

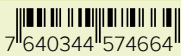
Gleithülse aus Edelstahl

- Edelstahlhülse für Einzel Schubdorne
- Für Durchmesser 20 / 22 / 25 / 30 / 35 mm
- Aus hochwertigem Edelstahl hergestellt
- Nagelplatte und Federelement integriert



QR-Code klickbar

Artikelnummer	EAN Code	für Schubdorn-Länge mm	ø mm	Preis CHF	ME
8139525	 7 640344 574640	300	20	11.70	Stk
8139526	 7 640344 574657	350	20	12.30	Stk
8139527	 7 640344 574664	400	20	12.70	Stk
8139528	 7 640344 574671	500	20	13.50	Stk
8139529	 7 640344 574688	300	22	14.60	Stk
8139530	 7 640344 574695	300	25	15.40	Stk
8139531	 7 640344 574701	400	25	19.30	Stk

Artikelnummer	EAN Code	für Schubdorn-Länge mm	ø mm	Preis CHF	ME
8139532	 7 640344 574718	500	25	20.50	Stk
8139533	 7 640344 574725	300	30	16.90	Stk
8139534	 7 640344 574732	350	30	17.20	Stk
8139535	 7 640344 574749	400	30	17.60	Stk
8139536	 7 640344 574756	500	30	18.20	Stk
8139537	 7 640344 574763	350	35	21.80	Stk
8139538	 7 640344 574770	400	35	23.00	Stk



Q-Edelstahlhülse

- Edelstahlhülse für Einzel Schubdorne in 1.4301
- Für Durchmesser 20 / 22 / 25 / 30 / 35 mm
- Integrierte Rechteckhülse
- Axiale und längs Verschiebbarkeit in Fugenlängsrichtung
- Aus hochwertigem Edelstahl hergestellt
- Nagelplatte und Federelement integriert









QR-Code klickbar

Artikelnummer	EAN Code	für Schubdorn-Länge mm	ø mm	Preis CHF	ME
8139539	 7 640344 574787	300	20	18.90	Stk
8139540	 7 640344 574794	350	20	19.30	Stk
8139541	 7 640344 574800	400	20	20.20	Stk
8139542	 7 640344 574817	500	20	25.30	Stk
8139543	 7 640344 574824	600	20	29.80	Stk
8139544	 7 640344 574831	300	22	24.70	Stk
8139545	 7 640344 574848	350	22	25.90	Stk
8139546	 7 640344 574855	300	25	36.20	Stk

BEWEHRUNGSTECHNIK

Einzelstabdorne

Artikelnummer	EAN Code	für Stabdorn-Länge mm	ø mm	Preis CHF	ME
<u>8139547</u>	 7 640344 574862	350	25	39.00	Stk
<u>8139548</u>	 7 640344 574879	500	25	48.80	Stk
<u>8139549</u>	 7 640344 574886	300	30	27.60	Stk
<u>8139550</u>	 7 640344 574893	350	30	28.80	Stk
<u>8139551</u>	 7 640344 574909	400	30	29.70	Stk
<u>8139552</u>	 7 640344 574916	400	35	59.30	Stk

BEWEHRUNGSZUBEHÖR



Abstandhalter 36



Arbeitssicherheit 55



Federstahlbinder 55



Drahtbinder 56





Drunterleiste mit Aussparung

- Drunterleiste mit Aussparungen für besseren Betondurchfluss
- Erfüllt den Frost-Tausalz-Widerstand nach SIA 262/1, Anhang C
- Geprüft nach DBV-Merkblatt „Abstandhalter“ DBV - c - L2/F
- Abstandhalter zur Sicherstellung der unteren Betondeckung
- Höhen von 15 mm bis 80 mm erhältlich
- Standardlänge 2.00 Meter
- Für Temperaturen unter 5 Grad empfehlen wir DRUPAK einzusetzen

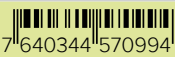

QR-Code klickbar

Artikelnummer	EAN Code	Überdeckung mm	Bund / Palette	Preis CHF	ME
8148935	7 ⁶⁴⁰³⁴⁴ 570925	15	100 m / 7700 m	46.50	100
8148936	7 ⁶⁴⁰³⁴⁴ 570932	20	100 m / 6300 m	47.50	100
8148937	7 ⁶⁴⁰³⁴⁴ 570949	25	100 m / 4900 m	50.00	100
8148938	7 ⁶⁴⁰³⁴⁴ 570956	30	100 m / 4200 m	52.50	100
8148939	7 ⁶⁴⁰³⁴⁴ 570963	35	60 m / 2520 m	72.50	100
8148940	7 ⁶⁴⁰³⁴⁴ 570970	40	60 m / 2400 m	82.50	100
8139283	7 ⁶⁴⁰³⁴⁴ 570987	45	60 m / 1440 m	112.50	100

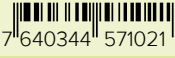
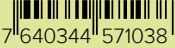
Artikelnummer	EAN Code	Überdeckung mm	Bund / Palette	Preis CHF	ME
8148941	 7 ⁶⁴⁰³⁴⁴ 570994	50	60 m / 1680 m	115.00	100
8148942	 7 ⁶⁴⁰³⁴⁴ 571007	60	40 m / 1200 m	210.00	100
8148943	 7 ⁶⁴⁰³⁴⁴ 571014	70	40 m / 1120 m	285.00	100
8148944	 7 ⁶⁴⁰³⁴⁴ 571021	75	40 m / 960 m	325.00	100
8148945	 7 ⁶⁴⁰³⁴⁴ 571038	80	40 m / 960 m	365.00	100





Drunterleiste mit Aussparung verstärkt



- Drunterleiste mit Aussparungen für besseren Betondurchfluss
- Erfüllt den Frost-Tausalz-Widerstand nach SIA 262/1, Anhang C
- Geprüft nach DBV-Merkblatt „Abstandhalter“ DBV - c - L2/F
- Abstandhalter zur Sicherstellung der unteren Betondeckung
- Höhen von 15 mm bis 80 mm erhältlich
- Standardlänge 2.00 Meter
- Für Temperaturen unter 5 Grad empfehlen wir DRUPAK einzusetzen

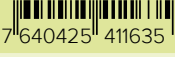

QR-Code klickbar

Artikelnummer	EAN Code	Qualität	Überdeckung mm	Bund / Palette	Preis CHF	ME
8148936	 7 ⁶⁴⁰⁴²⁵ 414025	verstärkt	20	100 m / 6300 m	53.20	100
8170716	 7 ⁶⁴⁰⁴²⁵ 411611	verstärkt	25	100 m / 4200 m	56.00	100
8170717	 7 ⁶⁴⁰⁴²⁵ 411628	verstärkt	30	100 m / 3600 m	58.80	100
8170718	 7 ⁶⁴⁰⁴²⁵ 411635	verstärkt	35	60 m / 2520 m	81.20	100
8170719	 7 ⁶⁴⁰⁴²⁵ 411642	verstärkt	40	60 m / 2520 m	92.40	100



Raster-Fix

- Drunterleiste mit Abstandshilfen zum Verlegen der Armierung
- Erfüllt den Frost-Tausalz-Widerstand nach SIA 262/1, Anhang C
- Geprüft nach DBV-Merkblatt „Abstandhalter“ DBV - c - L2/F
- Abstandhalter zur Sicherstellung der unteren Betondeckung
- Kippsicher wegen breiter Profilbreite (~43 mm)
- Höhen von 20 mm bis 50 mm erhältlich
- Standardlänge 2.00 Meter

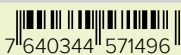
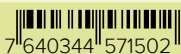
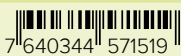
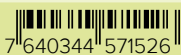
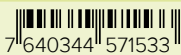
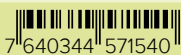

QR-Code klickbar

Artikelnummer	EAN Code	Überdeckung mm	Bund / Palette	Preis CHF	ME
8139298	 7 ⁶⁴⁰³⁴⁴ 571496	20	80 m / 3360 m	81.00	100
8139299	 7 ⁶⁴⁰³⁴⁴ 571502	25	80 m / 2880 m	86.00	100
8139300	 7 ⁶⁴⁰³⁴⁴ 571519	30	80 m / 2400 m	90.00	100
8139301	 7 ⁶⁴⁰³⁴⁴ 571526	35	80 m / 2400 m	130.00	100
8139302	 7 ⁶⁴⁰³⁴⁴ 571533	40	64 m / 1920 m	149.00	100
8139303	 7 ⁶⁴⁰³⁴⁴ 571540	50	64 m / 1536 m	225.00	100



Drunterleiste voll mit Loch

- Drunterleiste voll mit seitlichen Durchfluss-Löchern
- Erfüllt den Frost-Tausalz-Widerstand nach SIA 262/1, Anhang C
- Geprüft nach DBV-Merkblatt „Abstandhalter“ DBV - c - L2/F
- Abstandhalter zur Sicherstellung der unteren Betondeckung
- Einsätze auf weichem Untergrund geeignet (z.Bsp. Isolation)
- Höhen von 25mm bis 70mm erhältlich
- Standardlänge 2.00 Meter



QR-Code klickbar

Artikelnummer	EAN Code	Überdeckung mm	Bund / Palette	Preis CHF	ME
8148951	 7 ⁶⁴⁰³⁴⁴ 571090	25	100 m / 4900 m	65.00	100

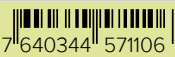
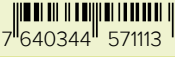
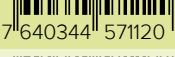
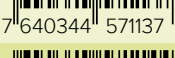
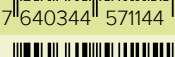
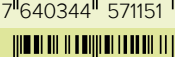
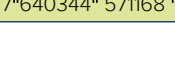
Artikelnummer	EAN Code	Überdeckung mm	Bund / Palette	Preis CHF	ME
8148952		30	100 m / 4200 m	68.00	100
8148953		35	60 m / 2880 m	98.00	100
8148954		40	60 m / 2400 m	112.00	100
8148955		45	60 m / 1440 m	152.00	100
8148956		50	60 m / 1680 m	168.00	100
8148957		60	40 m / 1200 m	285.00	100
8148958		70	40 m / 1120 m	330.00	100



Drunterleiste voll mit Loch verstärkt

- Drunterleiste voll mit seitlichen Durchfluss-Löchern (verstärkte Variante)
- Erfüllt den Frost-Tausalz-Widerstand nach SIA 262/1, Anhang C
- Geprüft nach DBV-Merkblatt „Abstandhalter“ DBV - c - L2/F
- Abstandhalter zur Sicherstellung der unteren Betondeckung
- Einsätze auf weichem Untergrund geeignet (z.Bsp. Isolation)
- Höhen von 25mm bis 70mm erhältlich
- Standardlänge 2.00 Meter

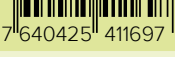
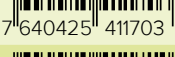
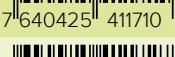
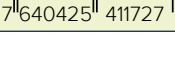

QR-Code klickbar

Artikelnummer	EAN Code	Qualität	Überdeckung mm	Bund / Palette	Preis CHF	ME
9089637		verstärkt	20	100 m / 6300 m	67.20	100
8170720		verstärkt	25	100 m / 4200 m	72.80	100
8170721		verstärkt	30	100 m / 3600 m	76.20	100
8170722		verstärkt	35	60 m / 2880 m	109.80	100
8170723		verstärkt	40	60 m / 2400 m	125.40	100



DRUPAK

- Substitutionsprodukt zur Drunterleiste I Vorteile bei Temperaturen < 5 Grad
- Grossflächiger und besonders stabiler Abstandhalter
- Distanzhalter für die 1. und 2. Lage
- Hergestellt aus 100% recyceltem, PVC-freien Kunststoff
- Guter Betondurchfluss dank optimaler Geometrie
- Erfüllt den Frost-Tausalz-Widerstand nach SIA 262/1, Anhang C
- Auflagebreite bis Höhe 30mm bei 36mm
- Auflagebreite ab Höhe 35mm bei 46mm

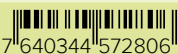
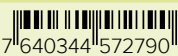
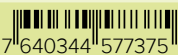
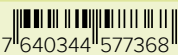
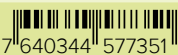

QR-Code klickbar

Artikelnummer	EAN Code	Überdeckung mm	Bund / Palette	Preis CHF	ME
8148975	 7 ⁶⁴⁰³⁴⁴ 577382	20	100 m / 6000 m	47.50	100
8148974	 7 ⁶⁴⁰³⁴⁴ 572806	25	100 m / 5400 m	47.50	100
8139393	 7 ⁶⁴⁰³⁴⁴ 572790	30	100 m / 5400 m	50.00	100
8139394	 7 ⁶⁴⁰³⁴⁴ 577375	35	60 m / 3900 m	72.50	100
8139395	 7 ⁶⁴⁰³⁴⁴ 577368	40	60 m / 3600 m	82.50	100
8139396	 7 ⁶⁴⁰³⁴⁴ 577351	50	60 m / 3000 m	125.00	100

DRUWA Abstandhalter



- Großflächiger Abstandhalter mit hoher Trittstabilität, bruchsicher
- Aufgrund seiner Zick-Zack-Form ist ein optimaler Betonfluss garantiert
- Erfüllt den Frost-Tausalz-Widerstand nach SIA 262/1, Anhang C
- Geprüft nach DBV-Merkblatt „Abstandhalter“ DBV - c - L2/F
- Abstandhalter zur Sicherstellung der unteren Betondeckung
- DRUWA kann durch Umdrehen auf weichen Untergründen verwendet werden
- Höhen von 15 mm bis 50 mm erhältlich
- Länge: 0.80 Meter / Stück (Abgew. Länge 1.00 Meter)

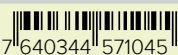

QR-Code klickbar

Artikelnummer	EAN Code	Überdeckung mm	Bund / Palette	Preis CHF	ME
8148947	 7 ⁶⁴⁰³⁴⁴ 571045	25	40 Stk. / 2800 Stk.	72.00	100

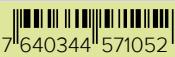
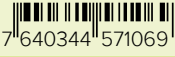
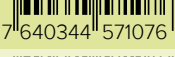
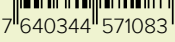
Artikelnummer	EAN Code	Überdeckung mm	Bund / Palette	Preis CHF	ME
8148946		30	40 Stk. / 2520 Stk.	75.00	100
8148948		35	30 Stk. / 2100 Stk.	108.00	100
8148949		40	30 Stk. / 1890 Stk.	125.00	100
8148950		50	20 Stk. / 1400 Stk.	190.00	100

Kamm Abstandhalter



- Schnell verlegt
- Kein aufwändiges Schliessen von Zwischenräumen mit Bauschaum oder dergleichen
- Verbleibt im Beton ohne Ausschalen



QR-Code klickbar

Artikelnummer	EAN Code	Länge	Überdeckung mm	Karton / Palette	Preis CHF	ME
8170700		1m	30	16 m / 720 m	4.00	m





Ringabstandhalter

- Universell einsetzbar (für Eisen Ø 4 mm - 12 mm)
- Abstandhalter für senkrechte Bewehrung
- Schnelle und einfache Befestigung an der Bewehrung
- Geprüft nach DBV-Merkblatt Abstandhalter DBV - c - L1/F/T/A
- Materialbedarf: ca. 3 - 4 Stück pro Quadratmeter
- Verpackung: transparente Kunststoff-Säcke

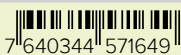
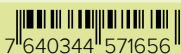
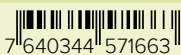

QR-Code klickbar

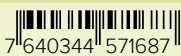
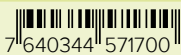
Artikelnummer	EAN Code	Überdeckung mm	Sack / Palette	Preis CHF	ME
8139314	 7 ⁶⁴⁰³⁴⁴ 571649	15	1000 Stk. / 60000 Stk.	31.00	1000
8139315	 7 ⁶⁴⁰³⁴⁴ 571656	20	1000 Stk. / 50000 Stk.	31.00	1000
8139316	 7 ⁶⁴⁰³⁴⁴ 571663	25	500 Stk. / 30000 Stk.	40.00	1000
8139317	 7 ⁶⁴⁰³⁴⁴ 571670	30	500 Stk. / 20000 Stk.	50.00	1000
8139318	 7 ⁶⁴⁰³⁴⁴ 571687	35	200 Stk. / 12000 Stk.	100.00	1000
8139319	 7 ⁶⁴⁰³⁴⁴ 571694	40	125 Stk. / 10000 Stk.	140.00	1000
8139320	 7 ⁶⁴⁰³⁴⁴ 571700	50	100 Stk. / 5000 Stk.	280.00	1000







Flügel Abstandhalter

- Aus hochschlagfestem Kunststoff
- Für die Armierungen bei Wänden und Pfeilern. Dank der eigenen Klemmwirkung schnelle Montage
- Der gleiche Halter kann für Armierungen \varnothing 4–16 mm bzw. je nach Typ bis 18mm eingesetzt werden



QR-Code klickbar

Artikelnummer	EAN Code	Überdeckung mm	Sack / Palette	Preis CHF	ME
9089715	 7 ⁶⁴⁰⁴²⁵ 414193	25	500 Stk. / 14000 Stk.	150.00	1000
9089716	 7 ⁶⁴⁰⁴²⁵ 414209	30	500 Stk. / 12000 Stk.	172.00	1000
9089717	 7 ⁶⁴⁰⁴²⁵ 414216	35	250 Stk. / 7000 Stk.	300.00	1000
9089718	 7 ⁶⁴⁰⁴²⁵ 414223	40	250 Stk. / 7000 Stk.	320.00	1000





Abstandhalter 4 Fuss Flach

- Für Eisen \varnothing 6mm bis 20 mm
- Stabiler Abstandhalter mit grossem Klemmbereich
- Für mittlere und schwere Armierung geeignet
- Für Betonelementwerke und für die Baustelle geeignet
- Ausführung mit ‚flachem‘ oder ‚spitzem‘ Fuss erhältlich
- ‚Spitzer Fuss‘ für Sichtbeton besser geeignet
- Verpackung: transparente Kunststoff-Säcke



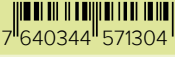

QR-Code klickbar

Artikelnummer	EAN Code	Überdeckung mm	Sack / Palette	Preis CHF	ME
8139321	 7 ⁶⁴⁰³⁴⁴ 571298	20	500 Stk. / 12000 Stk.	72.00	1000
8139322	 7 ⁶⁴⁰³⁴⁴ 571304	25	500 Stk. / 12000 Stk.	78.00	1000
8139323	 7 ⁶⁴⁰³⁴⁴ 571311	30	250 Stk. / 12000 Stk.	90.00	1000

BEWEHRUNGSZUBEHÖR

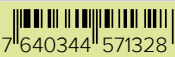
Abstandhalter

Artikelnummer	EAN Code	Überdeckung mm	Sack / Palette	Preis CHF	ME
8139324	 7 ⁶⁴⁰³⁴⁴ 571328	35	250 Stk. / 10000 Stk.	99.00	1000
8139325	 7 ⁶⁴⁰³⁴⁴ 571335	40	250 Stk. / 10000 Stk.	105.00	1000
8139326	 7 ⁶⁴⁰³⁴⁴ 571342	50	125 Stk. / 7500 Stk.	120.00	1000







Abstandhalter 4 Fuss Spitzig

- Für Eisen Ø 6mm bis 20 mm
- Stabiler Abstandhalter mit grossem Klemmbereich
- Für mittlere und schwere Armierung geeignet
- Für Betonelementwerke und für die Baustelle geeignet
- Ausführung mit ‚flachem‘ oder ‚spitzem‘ Fuss erhältlich
- ‚Spitzer Fuss‘ für Sichtbeton besser geeignet
- Verpackung: transparente Kunststoff-Säcke

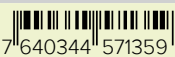
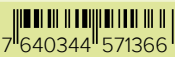

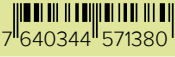
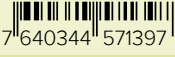
QR-Code klickbar

Artikelnummer	EAN Code	Überdeckung mm	Sack / Palette	Preis CHF	ME
8139327	 7 ⁶⁴⁰³⁴⁴ 571359	20	500 Stk. / 12000 Stk.	72.00	1000
8139328	 7 ⁶⁴⁰³⁴⁴ 571366	25	500 Stk. / 12000 Stk.	78.00	1000
8139329	 7 ⁶⁴⁰³⁴⁴ 571373	30	250 Stk. / 12000 Stk.	90.00	1000
8139330	 7 ⁶⁴⁰³⁴⁴ 571380	35	250 Stk. / 10000 Stk.	99.00	1000
8139331	 7 ⁶⁴⁰³⁴⁴ 571397	40	250 Stk. / 10000 Stk.	105.00	1000
8139332	 7 ⁶⁴⁰³⁴⁴ 571403	50	125 Stk. / 7500 Stk.	120.00	1000





BE-BETONABSTANDHALTER® Typ RL

- Betonabstandhalter für Wand- und Deckenbewehrungen
- Ausführung für die normale Anwendung
- Standardmässig mit verzinktem Bindedraht
- Spezialbetonmischung für die Schweiz
- Erfüllt den Frost-Tausalz-Widerstand nach SIA 262/1, Anhang C
- Erfüllt den Chlorid und Karbonatisierungswiderstand nach SIA262/1 Anhang B+I
- Verpackung: Stabile Gewebesäcke

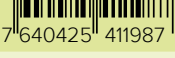
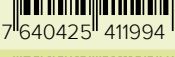
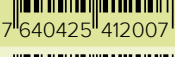
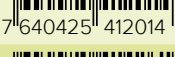
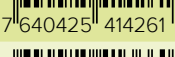
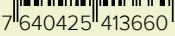

QR-Code klickbar

Artikelnummer	EAN Code	Überdeckung mm	Sack / Palette	Preis CHF	ME
8139795	 7 ⁶⁴⁰⁴²⁵ 411956	20	512 Stk. / 20480 Stk.	80.00	1000
8139796	 7 ⁶⁴⁰⁴²⁵ 411963	25	448 Stk. / 17920 Stk.	95.00	1000
8139797	 7 ⁶⁴⁰⁴²⁵ 411970	30	320 Stk. / 12800 Stk.	106.00	1000
8139798	 7 ⁶⁴⁰⁴²⁵ 411987	35	256 Stk. / 10240 Stk.	130.00	1000
8139799	 7 ⁶⁴⁰⁴²⁵ 411994	40	256 Stk. / 10240 Stk.	153.00	1000
8139800	 7 ⁶⁴⁰⁴²⁵ 412007	45	192 Stk. / 7680 Stk.	187.00	1000
8139801	 7 ⁶⁴⁰⁴²⁵ 412014	50	192 Stk. / 7680 Stk.	210.00	1000
	 7 ⁶⁴⁰⁴²⁵ 414261	55	196 Stk. / 7840 Stk.	210.00	1000
8139810	 7 ⁶⁴⁰⁴²⁵ 413660	60	147 Stk. / 5880 Stk.	360.00	1000





BE-BETONABSTANDHALTER® Typ RS

- Betonabstandhalter für Wand- und Deckenbewehrungen
- Extra grosse runde Auflagefläche
- extra stabile Ausführung
- Standardmässig mit verzinktem Bindedraht
- Spezialbetonmischung für die Schweiz
- Erfüllt den Frost-Tausalz-Widerstand nach SIA 262/1, Anhang C
- Erfüllt den Chlorid und Karbonatisierungswiderstand nach SIA262/1 Anhang B+I
- Verpackung: stabile Gewebesäcke

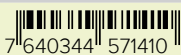
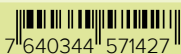
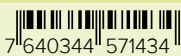
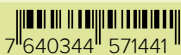
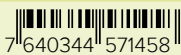
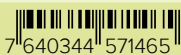
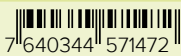

QR-Code klickbar

Artikelnummer	EAN Code	Überdeckung mm	Sack / Palette	Preis CHF	ME
8139333	 7 ⁶⁴⁰³⁴⁴ 571410	20	384 Stk. / 15360 Stk.	95.00	1000
8139334	 7 ⁶⁴⁰³⁴⁴ 571427	25	320 Stk. / 12800 Stk.	105.00	1000
8139335	 7 ⁶⁴⁰³⁴⁴ 571434	30	256 Stk. / 10240 Stk.	125.00	1000
8139336	 7 ⁶⁴⁰³⁴⁴ 571441	35	256 Stk. / 10240 Stk.	152.00	1000
8139337	 7 ⁶⁴⁰³⁴⁴ 571458	40	196 Stk. / 7840 Stk.	180.00	1000
8139338	 7 ⁶⁴⁰³⁴⁴ 571465	45	160 Stk. / 6400 Stk.	220.00	1000
8139339	 7 ⁶⁴⁰³⁴⁴ 571472	50	147 Stk. / 5880 Stk.	245.00	1000
8139340	 7 ⁶⁴⁰³⁴⁴ 571489	60	98 Stk. / 3920 Stk.	350.00	1000





QR-Code klickbar

BE-BETONABSTANDHALTER® Typ 3D

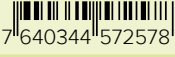
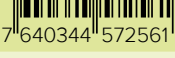
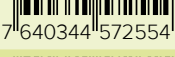
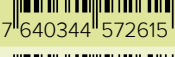
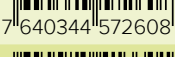
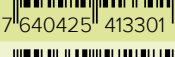
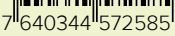

- Stabiler Sichtbetonabstandhalter für Wand- und Deckenbewehrungen
- 3- Punkteauflager mit verzinktem Bindedraht
- Extra grosse Aussparungen für den optimalen Betondurchfluss
- Spezialbetonmischung für die Schweiz
- Erfüllt den Frost-Tausalz-Widerstand nach SIA 262/1, Anhang C
- Erfüllt den Chlorid und Karbonatisierungswiderstand nach SIA262/1 Anhang B+
- Standardmässig mit verzinktem Bindedraht
- Verpackung: Stabile Gewebesäcke

Artikelnummer	EAN Code	Überdeckung mm	Sack / Palette	Preis CHF	ME
8139342	 7 ⁶⁴⁰³⁴⁴ 572837	20	384 Stk. / 15360 Stk.	255.00	1000
8139343	 7 ⁶⁴⁰³⁴⁴ 577405	25	384 Stk. / 15360 Stk.	275.00	1000
8139344	 7 ⁶⁴⁰³⁴⁴ 572578	30	320 Stk. / 12800 Stk.	310.00	1000
8139345	 7 ⁶⁴⁰³⁴⁴ 572561	35	256 Stk. / 10240 Stk.	350.00	1000
8139346	 7 ⁶⁴⁰³⁴⁴ 572554	40	192 Stk. / 7680 Stk.	388.00	1000
8139347	 7 ⁶⁴⁰³⁴⁴ 572615	45	147 Stk. / 5880 Stk.	416.00	1000
8139348	 7 ⁶⁴⁰³⁴⁴ 572608	50	147 Stk. / 5880 Stk.	447.00	1000
8139802	 7 ⁶⁴⁰⁴²⁵ 413301	55	147 Stk. / 5880 Stk.	495.00	1000
8139349	 7 ⁶⁴⁰³⁴⁴ 572585	60	115 Stk. / 4600 Stk.	530.00	1000





BE-BETONABSTANDHALTER® Typ 3K

- Stabiler Sichtbetonabstandhalter für Wand- und Deckenbewehrungen
- 3- Punkteauflager mit stabiler Doppelklammer
- Extra grosse Aussparungen für den optimalen Betondurchfluss
- Spezialbetonmischung für die Schweiz
- Erfüllt den Frost-Tausalz-Widerstand nach SIA 262/1, Anhang C
- Erfüllt den Chlorid und Karbonatisierungswiderstand nach SIA262/1 Anhang B+I
- Verpackung: Stabile Gewebesäcke

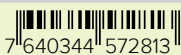
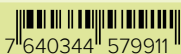
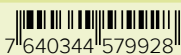
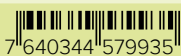
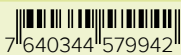
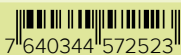
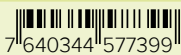

QR-Code klickbar

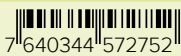
Artikelnummer	EAN Code	Überdeckung mm	Sack / Palette	Preis CHF	ME
8139364	 7 ⁶⁴⁰³⁴⁴ 572813	20	384 Stk. / 15360 Stk.	255.00	1000
8139694	 7 ⁶⁴⁰³⁴⁴ 579911	25	384 Stk. / 15360 Stk.	275.00	1000
8139695	 7 ⁶⁴⁰³⁴⁴ 579928	30	320 Stk. / 12800 Stk.	310.00	1000
8139696	 7 ⁶⁴⁰³⁴⁴ 579935	35	256 Stk. / 10240 Stk.	350.00	1000
8139697	 7 ⁶⁴⁰³⁴⁴ 579942	40	192 Stk. / 7680 Stk.	388.00	1000
8139367	 7 ⁶⁴⁰³⁴⁴ 572523	45	147 Stk. / 5880 Stk.	415.00	1000
8139368	 7 ⁶⁴⁰³⁴⁴ 577399	50	147 Stk. / 5880 Stk.	447.00	1000
8139803	 7 ⁶⁴⁰⁴²⁵ 413318	55	147 Stk. / 5880 Stk.	495.00	1000
8139369	 7 ⁶⁴⁰³⁴⁴ 572752	60	144 Stk. / 5760 Stk.	530.00	1000





QR-Code klickbar



BE-BETONABSTANDHALTER® Typ RK

- Sichtbetonabstandhalter für Wand- und Deckenbewehrungen
- 1-Punkteauflager mit stabiler Doppelklammer
- Extra stabile Ausführung
- Spezielle Tropfenform für den optimalen Betonfluss
- Spezialbetonmischung für die Schweiz
- Erfüllt den Frost-Tausalz-Widerstand nach SIA 262/1, Anhang C
- Erfüllt den Chlorid und Karbonatisierungswiderstand nach SIA262/1 Anhang B+I
- Verpackung: stabile Gewebesäcke

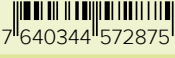
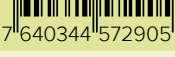
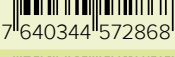
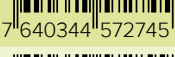
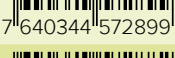
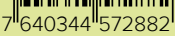
Artikelnummer	EAN Code	Überdeckung mm	Sack / Palette	Preis CHF	ME
8139370	 7 ⁶⁴⁰³⁴⁴ 572738	20	512 Stk. / 20480 Stk.	272.00	1000
8139371	 7 ⁶⁴⁰³⁴⁴ 572912	25	448 Stk. / 17920 Stk.	293.00	1000
8139372	 7 ⁶⁴⁰³⁴⁴ 572875	30	320 Stk. / 12800 Stk.	330.00	1000
8139373	 7 ⁶⁴⁰³⁴⁴ 572905	35	320 Stk. / 12800 Stk.	371.00	1000
8139374	 7 ⁶⁴⁰³⁴⁴ 572868	40	256 Stk. / 10240 Stk.	411.00	1000
8139375	 7 ⁶⁴⁰³⁴⁴ 572745	45	256 Stk. / 10240 Stk.	461.00	1000
8139376	 7 ⁶⁴⁰³⁴⁴ 572899	50	192 Stk. / 7680 Stk.	511.00	1000
8139377	 7 ⁶⁴⁰³⁴⁴ 572882	60	147 Stk. / 5880 Stk.	561.00	1000

BE-BETONABSTANDHALTER® Typ 4K



QR-Code klickbar



- Sichtbetonabstandhalter für Wand- und Deckenbewehrungen
- 4-Punkteauflager mit stabiler Doppelklammer
- Extra stabile Ausführung
- Spezialbetonmischung für die Schweiz
- Erfüllt den Frost-Tausalz-Widerstand nach SIA 262/1, Anhang C
- Erfüllt den Chlorid und Karbonatisierungswiderstand nach SIA262/1 Anhang B+I
- Verpackung: stabile Gewebesäcke

Artikelnummer	EAN Code	Überdeckung mm	Sack / Palette	Preis CHF	ME
8139378	7 640344 572851	20	384 Stk. / 23040 Stk.	255.00	1000
8139379	7 640344 572783	25	384 Stk. / 19200 Stk.	275.00	1000
8139380	7 640344 572776	30	320 Stk. / 12800 Stk.	310.00	1000
8139381	7 640344 572844	35	320 Stk. / 12800 Stk.	350.00	1000
8139382	7 640344 572929	40	256 Stk. / 10240 Stk.	395.00	1000
8139383	7 640344 572769	50	192 Stk. / 7680 Stk.	455.00	1000

BE-BETONABSTANDHALTER® Typ RD



QR-Code klickbar



- Sichtbetonabstandhalter für Wand- und Deckenbewehrungen
- 1-Punkteauflager mit Bindedraht
- Spezielle Tropfenform für den optimalen Betonfluss
- Spezialbetonmischung für die Schweiz
- Erfüllt den Frost-Tausalz-Widerstand nach SIA 262/1, Anhang C
- Erfüllt den Chlorid und Karbonatisierungswiderstand nach SIA262/1 Anhang B+I
- Standardmässig mit verzinktem Bindedraht
- Verpackung: stabile Gewebesäcke

Artikelnummer	EAN Code	Überdeckung mm	Sack / Palette	Preis CHF	ME
8139385	7 640344 572981	20	512 Stk. / 20480 Stk.	272.00	1000

Artikelnummer	EAN Code	Überdeckung mm	Sack / Palette	Preis CHF	ME
8139386	7 ⁶⁴⁰³⁴⁴ 573155	25	448 Stk. / 17920 Stk.	293.00	1000
8139387	7 ⁶⁴⁰³⁴⁴ 573056	30	320 Stk. / 12800 Stk.	330.00	1000
8139388	7 ⁶⁴⁰³⁴⁴ 573001	35	320 Stk. / 12800 Stk.	371.00	1000
8139389	7 ⁶⁴⁰³⁴⁴ 573018	40	256 Stk. / 10240 Stk.	411.00	1000
8139390	7 ⁶⁴⁰³⁴⁴ 573025	45	256 Stk. / 10240 Stk.	461.00	1000
8139391	7 ⁶⁴⁰³⁴⁴ 573032	50	192 Stk. / 7680 Stk.	511.00	1000
8139392	7 ⁶⁴⁰³⁴⁴ 573049	60	147 Stk. / 5880 Stk.	561.00	1000



BE-BETONABSTANDHALTER® Typ PRO

- Faserbetoneinzelabstandhalter
- Mit verzinktem Ösendraht
- Sehr Stabil / breite Schnittfläche
- Spezialbetonmischung für extrem hohe Frost-Tausalz-Widerstandsfähigkeit
- Erfüllt den Frost-Tausalz-Widerstand nach SIA 262/1, Anhang C
- Erfüllt den Chlorid und Karbonisierungswiderstand nach SIA262/1 Anhang B+I
- Geprüft nach BE FT II (400 Frost-Zyklen)
- Anforderungen für Objekte des Tiefbauamt Graubünden (TBA GR)
- Verpackung: stabile Gewebesäcke







QR-Code klickbar

Artikelnummer	EAN Code	Überdeckung mm	Sack / Palette	Preis CHF	ME
8139434	7 ⁶⁴⁰³⁴⁴ 573568	20	500 Stk. / 20000 Stk.	175.00	1000
8139435	7 ⁶⁴⁰³⁴⁴ 573575	25	500 Stk. / 17500 Stk.	179.00	1000
8139436	7 ⁶⁴⁰³⁴⁴ 573582	30	375 Stk. / 15000 Stk.	190.00	1000
8139437	7 ⁶⁴⁰³⁴⁴ 573599	35	250 Stk. / 12500 Stk.	210.00	1000
8139438	7 ⁶⁴⁰³⁴⁴ 573605	40	150 Stk. / 6000 Stk.	310.00	1000
8139439	7 ⁶⁴⁰³⁴⁴ 573612	45	125 Stk. / 5000 Stk.	325.00	1000
8139440	7 ⁶⁴⁰³⁴⁴ 573629	50	125 Stk. / 5000 Stk.	360.00	1000
8139441	7 ⁶⁴⁰³⁴⁴ 573636	55	100 Stk. / 4000 Stk.	382.00	1000

BEWEHRUNGSZUBEHÖR

Abstandhalter

Artikelnummer	EAN Code	Überdeckung mm	Sack / Palette	Preis CHF	ME
8139442	 7 640344 573643	60	100 Stk. / 4000 Stk.	405.00	1000
8139443	 7 640344 573650	65	50 Stk. / 2500 Stk.	430.00	1000
8139444	 7 640344 573667	70	50 Stk. / 2500 Stk.	430.00	1000
8139794	 7 640425 411789	80	50 Stk. / 1750 Stk.	475.00	1000

Flächenabstandhalter Dreikant

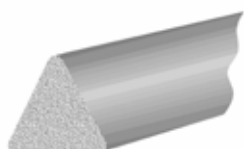

Die genaue Einhaltung der Betonüberdeckung ist entscheidend. Abstandhalter aus Faserbeton garantieren eine solche Betonüberdeckung und sind ausserdem aus hochfestem Faserbeton hergestellt, welche folgende Eigenschaften erfüllen:

- Frost-Tausalz-Widerstand nach SIA 262/1, Anhang C
- Grenzwert für TT-1 für einen hohen Frostausalz-Widerstand
- Sehr hohe Druckfestigkeit
- Perfekter Verbund mit dem Konstruktionsbeton



QR-Code klickbar

Artikelnummer	EAN Code	Länge mm	Höhe mm	Palette	Preis CHF	ME
9001410	 7 640344 579584	1000	20	1500 Stk.	180.00	100
9001411	 7 640344 576590	1000	25	1000 Stk.	210.00	100
9001392	 7 640344 573704	1000	30	750 Stk.	230.00	100
9001394	 7 640344 573711	1000	35	600 Stk.	280.00	100
9001395	 7 640344 573728	1000	40	400 Stk.	300.00	100
9001408	 7 640344 577047	1000	45	300 Stk.	360.00	100
9001396	 7 640344 573735	1000	50	250 Stk.	420.00	100
9001397	 7 640344 573742	1000	55	250 Stk.	520.00	100
9001409	 7 640344 579560	1000	60	250 Stk.	560.00	100
9001407	 7 640344 579768	1000	70	175 Stk.	720.00	100

Flächenabstandhalter Vierkant

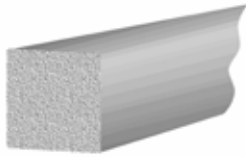

Die genaue Einhaltung der Betonüberdeckung ist entscheidend. Abstandhalter aus Faserbeton garantieren eine solche Betonüberdeckung und sind ausserdem aus hochfestem Faserbeton hergestellt, welche folgende Eigenschaften erfüllen:

- Frost-Tausalz-Widerstand nach SIA 262/1, Anhang C
- Grenzwert für TT-1 für einen hohen Frosttausalz-Widerstand
- Sehr hohe Druckfestigkeit
- Perfekter Verbund mit dem Konstruktionsbeton



QR-Code klickbar

Artikelnummer	EAN Code	Länge mm	Höhe mm	Palette	Preis CHF	ME
9001406	 7 ⁶⁴⁰³⁴⁴ 577467	1000	20	1000 Stk.	400.00	100
9001398	 7 ⁶⁴⁰³⁴⁴ 573773	1000	25	700 Stk.	430.00	100
9001399	 7 ⁶⁴⁰³⁴⁴ 573780	1000	30	500 Stk.	490.00	100
9001400	 7 ⁶⁴⁰³⁴⁴ 573797	1000	35	400 Stk.	560.00	100
9001401	 7 ⁶⁴⁰³⁴⁴ 573803	1000	40	250 Stk.	630.00	100
9001402	 7 ⁶⁴⁰³⁴⁴ 573810	1000	45	250 Stk.	750.00	100
9001403	 7 ⁶⁴⁰³⁴⁴ 573827	1000	50	200 Stk.	860.00	100
9001404	 7 ⁶⁴⁰³⁴⁴ 573834	1000	55	175 Stk.	1'190.00	100
9001405	 7 ⁶⁴⁰³⁴⁴ 573841	1000	60	125 Stk.	1'410.00	100
8139765	 7 ⁶⁴⁰³⁴⁴ 579577	1000	70	100 Stk.	1'500.00	100

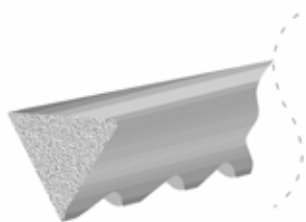

Flächenabstandhalter Dreikant Schlange

Die genaue Einhaltung der Betonüberdeckung ist entscheidend. Abstandhalter aus Faserbeton garantieren eine solche Betonüberdeckung und sind ausserdem aus hochfestem Faserbeton hergestellt, welche folgende Eigenschaften erfüllen:

- Frost-Tausalz-Widerstand nach SIA 262/1, Anhang C
- Grenzwert für TT-1 für einen hohen Frosttausalzwiderstand
- Sehr hohe Druckfestigkeit
- Perfekter Verbund mit dem Konstruktionsbeton

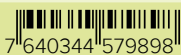

QR-Code klickbar

Artikelnummer	EAN Code	Länge mm	Höhe mm	Palette	Preis CHF	ME
9096994	 7 ⁶⁴⁰³⁴⁴ 579867	1000	20	1500 Stk.	170.00	100
9096995	 7 ⁶⁴⁰⁴²⁵ 411796	1000	25	1500 Stk.	190.00	100
9096988	 7 ⁶⁴⁰³⁴⁴ 573865	1000	30	1250 Stk.	210.00	100
9096991	 7 ⁶⁴⁰³⁴⁴ 579874	1000	35	1000 Stk.	260.00	100
9096987	 7 ⁶⁴⁰³⁴⁴ 573858	1000	40	750 Stk.	320.00	100
9096992	 7 ⁶⁴⁰³⁴⁴ 579881	1000	45	600 Stk.	370.00	100
9096989	 7 ⁶⁴⁰³⁴⁴ 573872	1000	50	600 Stk.	430.00	100
9096993	 7 ⁶⁴⁰³⁴⁴ 579898	1000	55	500 Stk.	490.00	100
9096990	 7 ⁶⁴⁰³⁴⁴ 579904	1000	60	400 Stk.	560.00	100

Schutzprofil SICURO

Erstes Gebot auf Baustellen ist der Schutz der Handwerker vor schweren oder gar tödlichen Verletzungen durch vorstehende Armierungseisen. SICURO hilft diese Verletzungen zu minimieren. Dank der **Stahleinlage** wird ein Durchstanzen der Armierungseisen zuverlässig verhindert.

Verpackung: Kartonschachteln à 112 Stk. / 1 Pal à 3 Kartonschachteln



QR-Code klickbar

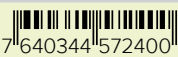

Artikelnummer	EAN Code	Länge m	Karton	Preis CHF	ME
8139104	 7 ⁶⁴⁰³⁴⁴ 572400	1.15	112 Stk.	9.50	Stk



Federstahlbinder

- Zum Verbinden von Bewehrungsstahl
- Einfache und schnelle Montage ohne Werkzeug
- Fester Sitz, wirtschaftlich und zeitsparend
- Auf Kartonstreifen geliefert
- Stahl 1 Ø von 6 mm bis 12 mm
- Stahl 2 Ø von 6 mm bis 20 mm
- Verpackung: In Kartonschachteln / Palett à 18 Karton



QR-Code klickbar

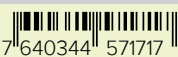
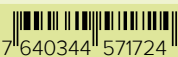

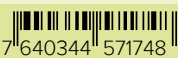
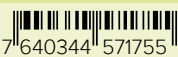
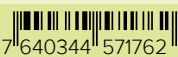
Artikelnummer	EAN Code	Stahl ø 2 mm	Stahl ø 1 mm	Karton / Palette	Preis CHF	ME
8139278	 7 ⁶⁴⁰³⁴⁴ 571717	6 bis 8	6 bis 8	10000 Stk. / 180000 Stk.	37.00	1000
8139279	 7 ⁶⁴⁰³⁴⁴ 571724	8 bis 10	6 bis 8	11200 Stk. / 201600 Stk.	44.00	1000
8139280	 7 ⁶⁴⁰³⁴⁴ 571731	10 bis 12	6 bis 8	9600 Stk. / 172800 Stk.	48.00	1000
8139284	 7 ⁶⁴⁰³⁴⁴ 571748	12 bis 14	6 bis 8	8000 Stk. / 144000 Stk.	50.00	1000
8139281	 7 ⁶⁴⁰³⁴⁴ 571755	14 bis 16	6 bis 8	6000 Stk. / 108000 Stk.	50.00	1000
8139282	 7 ⁶⁴⁰³⁴⁴ 571762	18 bis 20	6 bis 8	4000 Stk. / 72000 Stk.	56.00	1000

BEWEHRUNGSZUBEHÖR
Federstahlbinder

Artikelnummer	EAN Code	Stahl ø 2 mm	Stahl ø 1 mm	Karton / Palette	Preis CHF	ME
8139285	 7 640344 571779	12 bis 16	10 bis 12	4000 Stk. / 72000 Stk.	68.00	1000











Drahtbinder geschweisst verkupfert

- Eisendraht verkupfert
- Durchmesser 1.10 mm
- Bunde à 1'000 Stk.
- Stabil und reissfest



QR-Code klickbar



Artikelnummer	EAN Code	Länge cm	Sack / Palette	Preis CHF	ME
8148976	 7 640344 576156	10	20 Bd / 400 Bd	6.20	Bd
8139774	 7 640425 411802	12	20 Bd / 400 Bd	6.40	Bd
8139785	 7 640344 576170	14	20 Bd / 400 Bd	7.00	Bd
8139786	 7 640344 576187	16	15 Bd / 300 Bd	7.80	Bd
8148977	 7 640344 576194	18	15 Bd / 300 Bd	9.90	Bd
8148978	 7 640344 576200	20	10 Bd / 200 Bd	15.00	Bd
8148979	 7 640344 576217	22	10 Bd / 200 Bd	17.00	Bd
8148980	 7 640344 576224	24	10 Bd / 200 Bd	19.00	Bd
8148981	 7 640344 576231	26	10 Bd / 200 Bd	23.00	Bd
8148982	 7 640344 576248	28	10 Bd / 200 Bd	24.00	Bd
8148983	 7 640344 576255	30	10 Bd / 200 Bd	25.00	Bd









QR-Code klickbar

Drahtbinder geschweisst verzinkt

- Eisendraht verzinkt
- Durchmesser 1.10 mm
- Bunde à 1'000 Stk.
- Stabil und reissfest

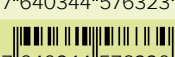

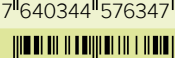
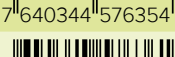
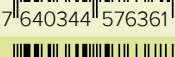
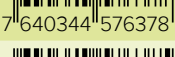



Artikelnummer	EAN Code	Länge cm	Sack / Palette	Preis CHF	ME
8148984	 7 ⁶⁴⁰³⁴⁴ 576279	10	20 Bd / 400 Bd	10.00	Bd
8148985	 7 ⁶⁴⁰³⁴⁴ 576293	12	20 Bd / 400 Bd	11.00	Bd
8148986	 7 ⁶⁴⁰³⁴⁴ 576309	14	20 Bd / 400 Bd	12.00	Bd
8148987	 7 ⁶⁴⁰³⁴⁴ 576316	16	15 Bd / 300 Bd	14.00	Bd
8148988	 7 ⁶⁴⁰³⁴⁴ 576323	18	15 Bd / 300 Bd	22.85	Bd
8148989	 7 ⁶⁴⁰³⁴⁴ 576330	20	10 Bd / 200 Bd	25.70	Bd
8148990	 7 ⁶⁴⁰³⁴⁴ 576347	22	10 Bd / 200 Bd	28.35	Bd
8148991	 7 ⁶⁴⁰³⁴⁴ 576354	24	10 Bd / 200 Bd	31.85	Bd
8148992	 7 ⁶⁴⁰³⁴⁴ 576361	26	10 Bd / 200 Bd	34.80	Bd
8148993	 7 ⁶⁴⁰³⁴⁴ 576378	28	10 Bd / 200 Bd	37.80	Bd
8148994	 7 ⁶⁴⁰³⁴⁴ 576385	30	10 Bd / 200 Bd	40.40	Bd

Drahtbinder geschweisst rostfrei

- Eisendraht aus Edelstahl
- Durchmesser 1.10 mm
- Bunde à 1'000 Stk.
- stabil und reissfest

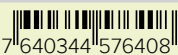

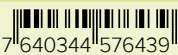
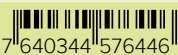
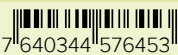
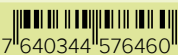
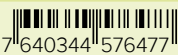
QR-Code klickbar

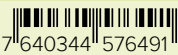
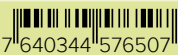
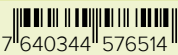
Artikelnummer	EAN Code	Länge cm	Sack / Palette	Preis CHF	ME
8148995	 7 ⁶⁴⁰³⁴⁴ 576408	10	20 Bd / 400 Bd	29.00	Bd
8148996	 7 ⁶⁴⁰³⁴⁴ 576422	12	20 Bd / 400 Bd	30.00	Bd
8148997	 7 ⁶⁴⁰³⁴⁴ 576439	14	20 Bd / 400 Bd	32.00	Bd
8148998	 7 ⁶⁴⁰³⁴⁴ 576446	16	15 Bd / 300 Bd	36.00	Bd
8148999	 7 ⁶⁴⁰³⁴⁴ 576453	18	15 Bd / 300 Bd	40.00	Bd
8149000	 7 ⁶⁴⁰³⁴⁴ 576460	20	10 Bd / 200 Bd	48.00	Bd
8149001	 7 ⁶⁴⁰³⁴⁴ 576477	22	10 Bd / 200 Bd	52.00	Bd
8149002	 7 ⁶⁴⁰³⁴⁴ 576484	24	10 Bd / 200 Bd	60.00	Bd
8149003	 7 ⁶⁴⁰³⁴⁴ 576491	26	10 Bd / 200 Bd	66.00	Bd
8149004	 7 ⁶⁴⁰³⁴⁴ 576507	28	10 Bd / 200 Bd	75.00	Bd
8149005	 7 ⁶⁴⁰³⁴⁴ 576514	30	10 Bd / 200 Bd	95.00	Bd







Drahtbinder doppelt geschweisst verkupfert

- Eisendraht doppelt, geschweisst, verkupfert
- Durchmesser 1.10 mm
- Bunde à 1'000 Stk.
- Stabil und reissfest



QR-Code klickbar

Artikelnummer	EAN Code	Länge cm	Sack / Palette	Preis CHF	ME
8170697	 7 ⁶⁴⁰³⁴⁴ 576804	12	15 Bd / 375 Bd	11.00	Bd
8170714	 7 ⁶⁴⁰⁴²⁵ 413981	10	15 Bd / 375 Bd	10.50	Bd
8170698	 7 ⁶⁴⁰³⁴⁴ 576811	14	15 Bd / 375 Bd	12.25	Bd
8170699	 7 ⁶⁴⁰³⁴⁴ 576828	16	10 Bd / 250 Bd	14.25	Bd
8170715	 7 ⁶⁴⁰⁴²⁵ 413998	18	10 Bd / 250 Bd	15.25	Bd



Drahtbinder geschlauft schwarz

- Durchmesser 1.10 mm
- Bunde à 1'000 Stk.
- stabil und reissfest



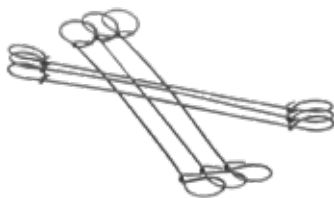

QR-Code klickbar

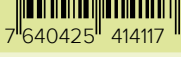
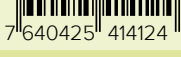

Artikelnummer	EAN Code	Länge cm	Sack / Palette	Preis CHF	ME
8188772	 7 ⁶⁴⁰⁴²⁵ 414087	120	20 Bd / 240 Bd	5.15	Bd
8188773	 7 ⁶⁴⁰⁴²⁵ 414094	140	20 Bd / 240 Bd	6.25	Bd

BEWEHRUNGSZUBEHÖR**Drahtbinder**

Artikelnummer	EAN Code	Länge cm	Sack / Palette	Preis CHF	ME
<u>8188774</u>	 7 640425 414100	160	20 Bd / 240 Bd	6.60	Bd
<u>8188775</u>	 7 640425 414117	180	20 Bd / 180 Bd	7.00	Bd
<u>8188776</u>	 7 640425 414124	200	20 Bd / 180 Bd	7.90	Bd
<u>8188777</u>	 7 640425 414131	220	20 Bd / 180 Bd	8.60	Bd

SCHALUNGSZUBEHÖR

	Distanzrohre	63
	Anschlaghalterung	77
	Winkel und Zubehör	80
	DYWIDAG	83
	Schalungsprofile	89
	Ankerhülsen	94
	ZEMBORD	95
	RAPIDOBORD	102



QR-Code klickbar

BE-OPTI

BE-OPTI® ist eine einteilige Schalungsspannstelle und zeichnet sich durch seine Stabilität aus.









- Lieferung im Set: Jede Spannstelle inklusive 2 BE-OPTI® Stopfen
- Sonderlängen werden auf Wunsch gefertigt

Prüfberichte:

- Wasserdichtheitsprüfung
- Brandverhalten F180

Verpackung: In transparenten Kunststoff-Säcken à 100 Bindestellen und 200 Stopfen

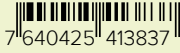
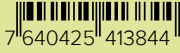
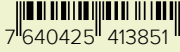
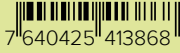

Artikelnummer	EAN Code	Wandstärke mm	ø innen mm	Sack / Palette	Preis CHF	ME
8188778	 7 ⁶⁴⁰⁴²⁵ 413776	150	22	100 Stk. / 5000 Stk.	38.00	100
8170702	 7 ⁶⁴⁰⁴²⁵ 413783	180	22	100 Stk. / 5000 Stk.	39.00	100
8170703	 7 ⁶⁴⁰⁴²⁵ 413790	200	22	100 Stk. / 4000 Stk.	43.00	100
8170704	 7 ⁶⁴⁰⁴²⁵ 413806	220	22	100 Stk. / 4000 Stk.	45.00	100
9089632	 7 ⁶⁴⁰⁴²⁵ 413813	240	22	100 Stk. / 4000 Stk.	46.00	100
8170705	 7 ⁶⁴⁰⁴²⁵ 413820	250	22	100 Stk. / 4000 Stk.	47.00	100
9089635	 7 ⁶⁴⁰⁴²⁵ 413837	280	22	100 Stk. / 4000 Stk.	52.00	100
8170706	 7 ⁶⁴⁰⁴²⁵ 413844	300	22	100 Stk. / 4000 Stk.	53.00	100
9089713	 7 ⁶⁴⁰⁴²⁵ 413851	350	22	75 Stk. / 3000 Stk.	59.00	100
9089714	 7 ⁶⁴⁰⁴²⁵ 413868	400	22	75 Stk. / 3000 Stk.	66.00	100
9089721	 7 ⁶⁴⁰⁴²⁵ 414612	450	22	50 Stk. / 3000 Stk.	67.00	100

BE-OPTI Konus

Betongrauer Konus mit Wassersperre zur Vergrößerung der Auflagefläche der Distanzrohre auf der Schalung



QR-Code klickbar

Artikelnummer	EAN Code	ø innen mm	Sack / Palette	Preis CHF	ME
9089722	 7 640425 414629	22	500 / 25000	85.00	1000

BE-OPTI Stopfen

Zum Verschliessen von BE-OPTI Konen



QR-Code klickbar

Artikelnummer	EAN Code	Farbe	ø innen mm	Sack / Palette	Preis CHF	ME
9089723	 7 640425 414636	Grau	22	500 Stk. / 100000 Stk.	40.00	1000



QR-Code klickbar

BE-GON® STANDARD

BE-GON® ist eine einteilige Schalungsspannstelle in besonders großzügiger Ausführung. Beständig gegen am Bau übliche Säuren und Laugen.

- Lieferung im Set: Jede Spannstelle inklusive 2 BE-GON® Stopfen
- Sonderlängen werden auf Wunsch gefertigt

Prüfberichte:

- Wasserdichtheitsprüfung
- Trinkwassereignung
- Brandverhalten F180
- Luftschalldämmung
- Aggressive Gewässer

Verpackung: In transparenten Kunststoff-Säcken à 100 Bindestellen und 200 Stopfen



Artikelnummer	EAN Code	Wandstärke mm	ø innen mm	Sack / Palette	Preis CHF	ME
8139066	7 640344 572486	150	22	100 Stk. / 2400 Stk.	63.00	100
8139067	7 640344 570024	175	22	100 Stk. / 2400 Stk.	64.00	100
8139068	7 640344 570031	180	22	100 Stk. / 3000 Stk.	64.00	100
8139069	7 640344 570048	200	22	100 Stk. / 2400 Stk.	64.00	100
8139070	7 640344 570055	220	22	100 Stk. / 2400 Stk.	66.00	100
8139071	7 640344 570062	240	22	100 Stk. / 2400 Stk.	66.00	100
8139072	7 640344 570079	250	22	100 Stk. / 2400 Stk.	66.00	100
8139073	7 640344 570086	300	22	100 Stk. / 2400 Stk.	72.00	100
8139074	7 640344 570093	350	22	100 Stk. / 1500 Stk.	88.00	100
8139075	7 640344 570109	360	22	100 Stk. / 1500 Stk.	89.00	100
8139076	7 640344 570116	365	22	100 Stk. / 1500 Stk.	89.00	100
8139077	7 640344 570123	400	22	100 Stk. / 1500 Stk.	103.00	100
8139078	7 640344 570130	450	22	50 Stk. / 800 Stk.	108.00	100
8139079	7 640344 570147	500	22	50 Stk. / 800 Stk.	112.00	100
8139080	7 640344 570154	550	22	50 Stk. / 800 Stk.	116.00	100
8139081	7 640344 570161	600	22	50 Stk. / 800 Stk.	121.00	100



BE-GON® STANDARD KONUS

BE-GON® STANDART Konus 22 aus Kunststoff für die Selbsterstellung von wasserdichten Spannstellen. Durch Ablängen eines Kunststoffrohres 22/26mm um 8cm kürzer als die gewünschte Wandstärke und Aufpressen des Konus, können Längen mit den Eigenschaften von BE-GON® STANDART 22 hergestellt werden. Verpackung: Transparente Kunststoff-Säcke



QR-Code klickbar

Artikelnummer	EAN Code	Länge mm	ø innen mm	Sack / Palette	Preis CHF	ME
8139675	7 640344 577641	50	22	200 / 5000	18.00	100

BE-GON PLUS® ø22

BEGON-Plus® ist eine einteilige Schalungsspannstelle mit vormontierten Konen in besonders großzügiger Ausführung. Beständig gegen am Bau übliche Säuren und Laugen.



- Lieferung im Set: Jede Spannstelle inklusive 2 BE-GON® Stopfen
- Sonderlängen werden auf Wunsch gefertigt
- Geeignet für Sichtbeton (komplettes Zubehör dazu erhältlich)
- Verpackung à 100 Bindestellen und 200 Stopfen
- Verpackung in transparenten Kunststoff-Säcken
- Bestellen Sie unsere Musterbox (mit diversen Sichtbetonabdeckungen)







Prüfberichte:

- Wasserdichtheitsprüfung
- Trinkwassereignung
- Brandverhalten F180
- Luftschalldämmung
- Aggressive Gewässer



QR-Code klickbar

Artikelnummer	EAN Code	Wandstärke mm	ø innen mm	Sack / Palette	Preis CHF	ME
8139029	7 640344 570178	150	22	100 Stk. / 2400 Stk.	71.00	100
8139030	7 640344 570185	175	22	100 Stk. / 2400 Stk.	71.00	100
8139031	7 640344 570192	180	22	100 Stk. / 2400 Stk.	71.00	100
8139032	7 640344 570208	200	22	100 Stk. / 2400 Stk.	71.00	100
8139033	7 640344 570215	220	22	100 Stk. / 2400 Stk.	73.00	100
8139034	7 640344 570222	240	22	100 Stk. / 2400 Stk.	73.00	100

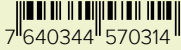
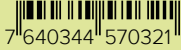
Artikelnummer	EAN Code	Wandstärke mm	ø innen mm	Sack / Palette	Preis CHF	ME
8139035	 7 ⁶⁴⁰³⁴⁴ 570239	250	22	100 Stk. / 2400 Stk.	73.00	100
8139036	 7 ⁶⁴⁰³⁴⁴ 570246	300	22	100 Stk. / 2400 Stk.	81.00	100
8139037	 7 ⁶⁴⁰³⁴⁴ 570253	350	22	100 Stk. / 1500 Stk.	101.00	100
8139038	 7 ⁶⁴⁰³⁴⁴ 570260	360	22	100 Stk. / 1500 Stk.	102.00	100
8139039	 7 ⁶⁴⁰³⁴⁴ 570277	365	22	100 Stk. / 1500 Stk.	103.00	100
8139040	 7 ⁶⁴⁰³⁴⁴ 570284	400	22	100 Stk. / 1500 Stk.	116.00	100
8139041	 7 ⁶⁴⁰³⁴⁴ 570291	450	22	50 Stk. / 800 Stk.	120.00	100
8139042	 7 ⁶⁴⁰³⁴⁴ 570307	500	22	50 Stk. / 800 Stk.	124.00	100
8139043	 7 ⁶⁴⁰³⁴⁴ 570314	550	22	50 Stk. / 800 Stk.	129.00	100
8139044	 7 ⁶⁴⁰³⁴⁴ 570321	600	22	50 Stk. / 800 Stk.	135.00	100

BE-GON® + BEGON PLUS® Stopfen

Prüfberichte von BE-GON® und BE-GON® PLUS sind nur gültig bei Verwendung dieses Stopfens

- Für BE-GON® und BE-GON® PLUS verwendbar
- Einfaches verschliessen der Spannstellen
- Einschlagen, muss nicht verklebt werden
- Verpackung: transparente Kunststoff-Säcke



QR-Code klickbar

Artikelnummer	EAN Code	Farbe	ø innen mm	Sack / Palette	Preis CHF	ME
8139046	 7 ⁶⁴⁰³⁴⁴ 570345	Grau	22	200 Stk. / 25000 Stk.	6.00	100



BE-GON PLUS® Sichtbetonscheibe aus Giessbeton

Prüfberichte für Wasserdichtheitsprüfung, Brandverhalten F180, Luftschalldämmung, Trinkwassereignung und Aggressive Gewässer sind nur gültig, sofern der BE-GON® / BE-GON® PLUS Stopfen ø22mm verwendet wird.

- Sonderlösung: Sichtbetonscheibe aus Giessbeton 22
- Wird auf den BE-GON® Stopfen 22 aufgeklebt
- Schattenfuge ca. 2mm
- Verpackung: Karton à 100 Stück



QR-Code klickbar

Artikelnummer	EAN Code	Farbe	ø innen mm	Sack	Preis CHF	ME
8139047	7 640344 570352	Grau	22	100 Stk.	220.00	100

BE-GON PLUS® Sichtbetonstopfen Kunststoff

Prüfberichte von der Bindstelle BE-GON® PLUS sind nur gültig bei Verwendung dieses BE-GON® PLUS Sichtbetonstopfen 22

- Für BE-GON® PLUS verwendbar
- Einfaches verschliessen der Spannstellen
- Einschlagen, muss nicht verklebt werden
- Kunststoff-Stopfen
- BE-GON® PLUS Sichtbetonstopfen
- Schattenfuge ca. 2mm
- Verpackung: Transparente Kunststoff-Säcke



QR-Code klickbar



Artikelnummer	EAN Code	Farbe	ø innen mm	Sack / Palette	Preis CHF	ME
8139048	7 640344 570369	Grau	22	200 Stk. / 25000 Stk.	120.00	100
8139049	7 640344 570376	Blau	22	200 Stk. / 25000 Stk.	120.00	100
8139050	7 640344 570383	Grün	22	200 Stk. / 25000 Stk.	120.00	100
8139051	7 640344 570390	Rot	22	200 Stk. / 25000 Stk.	120.00	100
8139052	7 640344 570406	Schwarz	22	200 Stk. / 25000 Stk.	120.00	100



QR-Code klickbar

BE-GON PLUS® Sichtbetonscheibe Edelstahl gedreht

Prüfberichte für Wasserdichtheitsprüfung, Brandverhalten F180, Luftschalldämmung, Trinkwassereignung und aggressive Gewässer sind nur gültig, sofern der BE-GON® / BE-GON PLUS® Stopfen ø22mm verwendet wird.

- Sonderlösung: Sichtbetonscheibe Edelstahl gedreht
- Wird auf den BE-GON® Stopfen 22 aufgeklebt
- Schattenfuge ca. 2 mm
- Verpackung: Einzelverpackung



Artikelnummer	EAN Code	Farbe	ø innen mm	Sack / Palette	Preis CHF	ME
8139110	7 640344 570611	Grau matt	22	100 Stk. / 2000 Stk.	12.50	Stk

BE-GON PLUS® Sichtbetonscheibe Edelstahl poliert

Prüfberichte für Wasserdichtheitsprüfung, Brandverhalten F180, Luftschalldämmung, Trinkwassereignung und aggressive Gewässer sind nur gültig, sofern der BEGON / BEGON-PLUS Stopfen ø22mm verwendet wird.

- Sonderlösung: Sichtbetonscheibe Edelstahl verchromt
- Wird auf den BEGON® Stopfen 22 aufgeklebt
- Schattenfuge ca. 2 mm
- Verpackung: Einzelverpackung



QR-Code klickbar

Artikelnummer	EAN Code	Farbe	ø innen mm	Sack / Palette	Preis CHF	ME
8139111	7 640344 570628	Grau glänzend	22	100 Stk. / 2000 Stk.	12.50	Stk



BE-GON® PLUS® Konus

BE-GON® PLUS Konus 22 aus Kunststoff für die Selbsterstellung von wasserdichten Spannstellen.
Durch Ablängen eines Kunststoffrohres 22/26mm um 8cm kürzer als die gewünschte Wandstärke und Aufpressen des Konus, können Längen mit den Eigenschaften von BE-GON® PLUS 22 hergestellt werden.
Verpackung: Transparente Kunststoff-Säcke



QR-Code klickbar

Artikelnummer	EAN Code	ø innen mm	Sack / Palette	Preis CHF	ME
8139045	7 640344 570338	22	200 Stk. / 5000 Stk.	22.00	100









BE-KON® mit Konen

- BE-KON® - Distanzrohr mit vormontierten Konen (blau)
- Durchmesser 22/26mm, aus Kunststoff
- BE-KON®-Konen „blau“
- Verpackung: In doppellagiger, nassfest verleimter Kartonschachtel

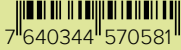

QR-Code klickbar

Artikelnummer	EAN Code	Wandstärke mm	ø innen mm	Karton / Palette	Preis CHF	ME
8139054	7 640344 570482	150	22	100 Stk. / 2400 Stk.	54.00	100
9089633	7 640425 414162	120	22	100 Stk. / 2400 Stk.	54.00	100
8139693	7 640344 577634	160	22	100 Stk. / 2400 Stk.	55.00	100
8139055	7 640344 570499	180	22	100 Stk. / 2400 Stk.	39.00	100
8139056	7 640344 570505	200	22	100 Stk. / 2400 Stk.	43.00	100
8139057	7 640344 570512	220	22	100 Stk. / 2400 Stk.	45.00	100

Artikelnummer	EAN Code	Wandstärke mm	ø innen mm	Karton / Palette	Preis CHF	ME
8139058	 7 ⁶ 640344 ⁵ 70529	240	22	100 Stk. / 2400 Stk.	46.00	100
8139059	 7 ⁶ 640344 ⁵ 70536	250	22	100 Stk. / 2400 Stk.	47.00	100
8139819	 7 ⁶ 640425 ⁴ 413752	260	22	100 Stk. / 2400 Stk.	48.00	100
8139060	 7 ⁶ 640344 ⁵ 70543	280	22	100 Stk. / 2400 Stk.	52.00	100
8139061	 7 ⁶ 640344 ⁵ 70550	300	22	100 Stk. / 2400 Stk.	53.00	100
8139062	 7 ⁶ 640344 ⁵ 70567	350	22	100 Stk. / 2400 Stk.	59.00	100
8139063	 7 ⁶ 640344 ⁵ 70574	400	22	100 Stk. / 1600 Stk.	66.00	100
8139105	 7 ⁶ 640344 ⁵ 70581	450	22	100 Stk. / 1600 Stk.	74.00	100
8139064	 7 ⁶ 640344 ⁵ 70598	500	22	100 Stk. / 1600 Stk.	82.00	100







Distanzrohre

- Distanzrohr ungeschnitten
- Für Normal- und Grossflächenschalungen
- Rohre à 2.00 Meter mit aufgerauter Oberfläche



QR-Code Klickbar

Artikelnummer	EAN Code	Wandstärke cm	ø innen mm	Bund / Palette	Preis CHF	ME
8139277	 7 ⁶ 640344 ⁵ 72592	variabel	22/26	50 m / 3600 m	63.00	100
9089724	 7 ⁶ 640425 ⁴ 414674	variabel	32/38	30 m / 1260 m	214.00	100
8139807	 7 ⁶ 640425 ⁴ 413639	variabel	22/28	50 m / 2450 m	82.00	100
9089711	 7 ⁶ 640425 ⁴ 414568	variabel	26/32	50 m / 1800 m	168.00	100
9089725	 7 ⁶ 640425 ⁴ 414681	variabel	40/46	30 m / 900 m	255.00	100





BE-KON® Konus

Der spezielle blaue BE-KON®-Konus garantiert eine optimale Spannstelle

- Verpackung: Transparente Kunststoff-Säcke
- für Distanzrohre 22/26 mm

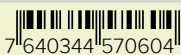

QR-Code klickbar



Artikelnummer	EAN Code	Farbe	ø innen mm	Sack / Palette	Preis CHF	ME
8139065	 7 ⁶⁴⁰³⁴⁴ 570604	Blau	22	500 Stk. / 30000 Stk.	60.00	1000
9089726	 7 ⁶⁴⁰⁴²⁵ 414704	Blau	32	500 Stk. / 25000 Stk.	154.00	1000
9089712	 7 ⁶⁴⁰⁴²⁵ 414575	Schwarz	26	500 Stk. / 4000 Stk.	115.00	1000
9089727	 7 ⁶⁴⁰⁴²⁵ 414711	Blau	40	125 Stk. / 15000 Stk.	381.00	1000

BE-KON® Stopfen

- Zum Verschliessen von BE-KON® Distanzrohren
- Für BE-KON®-Abstandsrohre 22/26 mm
- Extra helles ‚Betongrau‘
- Verpackung: Transparente Kunststoff-Säcke



QR-Code klickbar

Artikelnummer	EAN Code	Farbe	ø innen mm	Sack / Palette	Preis CHF	ME
8170701	 7 ⁶⁴⁰⁴²⁵ 413974	Grau	22	200 Stk. / 48000 Stk.	40.00	1000
9089728	 7 ⁶⁴⁰⁴²⁵ 414735	Grau	32	500 Stk. / 12000 Stk.	112.70	1000
9089636	 7 ⁶⁴⁰⁴²⁵ 414728	Grau	26	1000 Stk. / 24000 Stk.	72.00	1000

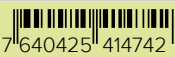



Artikelnummer	EAN Code	Farbe	ø innen mm	Sack / Palette	Preis CHF	ME
9089729	 7 640425 414742	Grau	40	250 Stk. / 6000 Stk.	195.00	1000

BE-KON® Dicht Stopfen

- Zum Abdichten von Spannstellen gegen Wasser
- Für BE-KON®-Abstandsrohre 22/26 mm
- Synonym für „Flupp“
- Verpackung: Transparente Kunststoff-Säcke

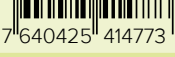

QR-Code klickbar

Artikelnummer	EAN Code	Farbe	ø innen mm	Sack / Palette	Preis CHF	ME
8139083	 7 640344 570642	Grau	22	500 Stk. / 50000 Stk.	160.00	1000
9089730	 7 640425 414759	Transparent	22	500 Stk. / 50000 Stk.	192.00	1000
9089732	 7 640425 414773	Grau	32	125 Stk. / 12500 Stk.	745.00	1000
9089731	 7 640425 414766	Grau	26	250 Stk. / 25000 Stk.	381.00	1000



BE-KON® Sichtbeton Konus

Vorgefertigter Kegel in hochwertiger Sichtbetonqualität zum Verschluss von Spannstellen mit Innendurchmesser 22 mm in Kombination mit Konen mit einer Einbaulänge von 10 mm.

- Nach dem Entfernen des Konus wird die Spannstelle mit dem Sichtbetonkegel Universal verschlossen. Der Sichtbetonkegel Universal muss nur eingesteckt werden, es ist kein Verkleben notwendig!
- Die Laschen am Kunststoffteil garantieren einen festen und zentrierten Sitz des Sichtbetonkegel Universal in der Spannstelle.
- Je nach verwendetem Konus ergibt sich eine kleine Schattenfuge.
- Der Sichtbetonkegel Universal ist nur zum optischen Verschluss der Spannstelle und bietet keinen Schutz gegen drückendes Wasser.



QR-Code klickbar

Artikelnummer	EAN Code	ø innen mm	Sack / Palette	Preis CHF	ME
8139805	 7 ⁶⁴⁰⁴²⁵ 413615	22	72 Stk. / 3960 Stk.	450.00	100

BE-SCHAL® Schalstopfen

- Zum Verschliessen von Bohrlöchern in Schalungen
- Schalstopfen aus äusserst hochwertigem Kunststoff
- Verschliesst verlässlich Löcher in Schalungen
- Für Bohrlöcher von Ø22 mm bis Ø25 mm geeignet
- Verpackung: Transparente Kunststoff-Säcke



QR-Code klickbar

Artikelnummer	EAN Code	Farbe	ø innen mm	Sack / Palette	Preis CHF	ME
8139341	 7 ⁶⁴⁰³⁴⁴ 570659	Grau	22 bis 25	100 Stk. / 50000 Stk.	145.00	1000
8139806	 7 ⁶⁴⁰⁴²⁵ 413622	Blau	22 bis 25	100 Stk. / 50000 Stk.	195.00	1000



QR-Code klickbar

Faserbetonrohr

- Verlorenes Faserbetonrohr 22 / 40 mm
- Überall einsetzbar wo kein Plastik akzeptiert wird
- Dywidag-Ankersröbe können wieder verwendet werden
- Spannstelle geeignet für wasserundurchlässige Bauteile

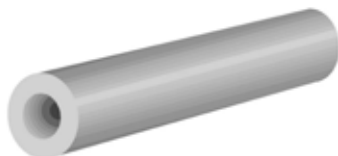

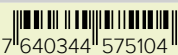
Artikelnummer	EAN Code	Länge cm	ø mm	Sack / Palette	Preis CHF	ME
8139567	 7 640344 575104	125	22/40	25 Stk. / 375 Stk.	6.80	Stk



Faserbetonstopfen

- Faserbeton-Verschluss-Stopfen
- Kompatibel zum Faserbetonrohr 22 / 20 mm

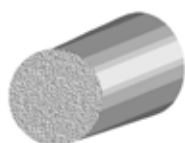

QR-Code klickbar

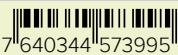

Artikelnummer	EAN Code	Länge mm	ø mm	Sack	Preis CHF	ME
8139462	 7 640344 573995	50	22	500 Stk.	33.00	100
9089720	 7 640425 414278	40	22	1000 Stk.	30.00	100
8139461	 7 640344 573988	20	22	1000 Stk.	27.00	100



Probeton

- Zweikomponentenkleber
- für das schnelle verschliessen der Faserbetonrohre

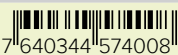

QR-Code klickbar

Artikelnummer	EAN Code	Gewicht Kg	Preis CHF	ME
8139463	 7 ⁶⁴⁰³⁴⁴ 574008	2	75.00	kg



Filou Frischbeton







Der Filou ist ein Anschlaghalter, welcher ein optimaler Distanzhalter für die Wandschalung ist. Durch die Verwendung kann die gewünschte Wandstärke exakt eingehalten werden.

- Beidseitiger Anschlaghalterung
- Schnelle und wirtschaftliche Montage
- Genaue Ausrichtung im Frischbeton
- Stabile Aretierung
- Exakte Einhaltung der Wandstärke
- Verpackung: Kartonschachtel



QR-Code klickbar

Artikelnummer	EAN Code	Wandstärke mm	Kessel / Palette	Preis CHF	ME
8139016	 7 ⁶⁴⁰³⁴⁴ 570796	100	50 Stk. / 1200 Stk.	2.20	Stk
8139017	 7 ⁶⁴⁰³⁴⁴ 570802	120	50 Stk. / 1200 Stk.	2.30	Stk
8139018	 7 ⁶⁴⁰³⁴⁴ 570819	150	50 Stk. / 1200 Stk.	2.20	Stk
8139019	 7 ⁶⁴⁰³⁴⁴ 570826	180	50 Stk. / 1200 Stk.	2.20	Stk
8139020	 7 ⁶⁴⁰³⁴⁴ 570833	200	50 Stk. / 1200 Stk.	2.25	Stk
8139021	 7 ⁶⁴⁰³⁴⁴ 570840	220	50 Stk. / 1200 Stk.	2.30	Stk

Artikelnummer	EAN Code	Wandstärke mm	Kessel / Palette	Preis CHF	ME
8139022	 7 ^M 640344 ^M 570857 ^M	240	50 Stk. / 1200 Stk.	2.30	Stk
8139023	 7 ^M 640344 ^M 570864 ^M	250	50 Stk. / 1200 Stk.	2.35	Stk
8139024	 7 ^M 640344 ^M 570871 ^M	300	50 Stk. / 1200 Stk.	2.40	Stk
8139025	 7 ^M 640344 ^M 570888 ^M	350	50 Stk. / 1200 Stk.	2.50	Stk
8139026	 7 ^M 640344 ^M 570895 ^M	400	50 Stk. / 1200 Stk.	2.60	Stk
8139027	 7 ^M 640344 ^M 570901 ^M	450	50 Stk. / 1200 Stk.	2.70	Stk
8139028	 7 ^M 640344 ^M 570918 ^M	500	50 Stk. / 1200 Stk.	2.80	Stk



Filou 1E

Der Filou 1E ist ein Anschlaghalter, welcher ein optimaler Distanzhalter für die Wandschalung ist. Durch die Verwendung kann die gewünschte Wandstärke exakt eingehalten werden.

- Einseitiger Anschlag | Durchmesser 6-12mm
- Kessel à 100 Stk. / Pal. à 2'400 Stk.
- Rasche Montage, ideal in Kombination für Abdichtungssysteme
- Kein durchgängiger Abstandhalter
- Geeignet für einhäuptige Schalungen
- Ermöglicht nach dem Betonieren eine Montage
- Exakte Einhaltung der Wandstärke
- Verpackung: Kunststoffeimer mit Haltegriff (100% recyclebar)



QR-Code klickbar

Artikelnummer	EAN Code	Stahl ø mm	Wandstärke mm	Kessel / Palette	Preis CHF	ME
8139003	 7 ^M 640344 ^M 570666 ^M	6 bis 12	Variabel	100 Stk. / 2400 Stk.	2.30	Stk



Filou 1D

Der Filou 1D ist ein Anschlaghalter, welcher ein optimaler Distanzhalter für die Wandschalung ist. Durch die Verwendung kann die gewünschte Wandstärke exakt eingehalten werden.

- Beidseitiger Anschlag | Durchmesser 6-12mm
- Kessel à 50 Stk. / Pal. à 1'200 Stk.
- Schnelle und wirtschaftliche Montage
- Ermöglicht nach dem Betonieren eine Montage
- Exakte Einhaltung der Wandstärke
- Verpackung: Kunststoffeimer mit Haltegriff (100% recyclebar)



QR-Code klickbar

Artikelnummer	EAN Code	Stahl ø mm	Wandstärke mm	Kessel / Palette	Preis CHF	ME
8139004	7 ⁶⁴⁰³⁴⁴ 572943	6 bis 12	120	50 Stk. / 1200 Stk.	2.30	Stk
8139005	7 ⁶⁴⁰³⁴⁴ 570673	6 bis 12	150	50 Stk. / 1200 Stk.	2.20	Stk
8139276	7 ⁶⁴⁰³⁴⁴ 570680	6 bis 12	160	50 Stk. / 1200 Stk.	2.20	Stk
8139006	7 ⁶⁴⁰³⁴⁴ 570697	6 bis 12	180	50 Stk. / 1200 Stk.	2.25	Stk
8139007	7 ⁶⁴⁰³⁴⁴ 570703	6 bis 12	200	50 Stk. / 1200 Stk.	2.25	Stk
8139008	7 ⁶⁴⁰³⁴⁴ 570710	6 bis 12	220	50 Stk. / 1200 Stk.	2.30	Stk
8139009	7 ⁶⁴⁰³⁴⁴ 570727	6 bis 12	240	50 Stk. / 1200 Stk.	2.30	Stk
8139010	7 ⁶⁴⁰³⁴⁴ 570734	6 bis 12	250	50 Stk. / 1200 Stk.	2.35	Stk
8139384	7 ⁶⁴⁰³⁴⁴ 572974	6 bis 12	260	50 Stk. / 1200 Stk.	2.35	Stk
8139761	7 ⁶⁴⁰³⁴⁴ 579362	6 bis 12	280	50 Stk. / 1200 Stk.	2.40	Stk
8139011	7 ⁶⁴⁰³⁴⁴ 570741	6 bis 12	300	50 Stk. / 900 Stk.	2.40	Stk
8139012	7 ⁶⁴⁰³⁴⁴ 570758	6 bis 12	350	50 Stk. / 900 Stk.	2.50	Stk
8139013	7 ⁶⁴⁰³⁴⁴ 570765	6 bis 12	400	50 Stk. / 900 Stk.	2.60	Stk
8139014	7 ⁶⁴⁰³⁴⁴ 570772	6 bis 12	450	50 Stk. / 1200 Stk.	2.70	Stk
8139015	7 ⁶⁴⁰³⁴⁴ 570789	6 bis 12	500	50 Stk. / 900 Stk.	2.80	Stk



Filou 2E

Der Filou 2E ist ein Anschlaghalter, welcher ein optimaler Distanzhalter für die Wandschalung ist. Durch die Verwendung kann die gewünschte Wandstärke exakt eingehalten werden.

- Einseitiger Anschlag | Durchmesser 14-20mm
- Kessel à 100 Stk. / Pal. à 2'400 Stk.
- Rasche Montage, ideal in Kombination für Abdichtungssysteme
- Kein durchgängiger Abstandhalter
- Geeignet für einhäuptige Schalungen
- Ermöglicht nach dem Betonieren eine Montage
- Exakte Einhaltung der Wandstärke
- Verpackung: Kunststoffeimer mit Haltegriff (100% recyclebar)



QR-Code klickbar

Artikelnummer	EAN Code	Stahl ø mm	Wandstärke mm	Kessel / Palette	Preis CHF	ME
8139350	 7 ^M 640344 ^M 572820 ^M	14 bis 20	Variabel	100 Stk. / 2400 Stk.	2.95	Stk





Filou 2D

Der Filou 2D ist ein Anschlaghalter, welcher ein optimaler Distanzhalter für die Wandschalung ist. Durch die Verwendung kann die gewünschte Wandstärke exakt eingehalten werden.

- Beidseitiger Anschlag | Durchmesser 14-20mm
- Kessel à 50 Stk. / Pal. à 1'200 Stk.
- Schnelle und wirtschaftliche Montage
- Ermöglicht nach dem Betonieren eine Montage
- Exakte Einhaltung der Wandstärke
- Verpackung: Kunststoffeimer mit Haltegriff (100% recyclebar)

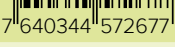
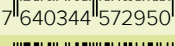
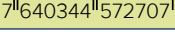

QR-Code klickbar

Artikelnummer	EAN Code	Stahl ø mm	Wandstärke mm	Kessel / Palette	Preis CHF	ME
8139351	 7 ^M 640344 ^M 577443 ^M	14 bis 20	120	50 Stk. / 1200 Stk.	2.95	Stk
8139352	 7 ^M 640344 ^M 572691 ^M	14 bis 20	150	50 Stk. / 1200 Stk.	2.85	Stk
8139353	 7 ^M 640344 ^M 572721 ^M	14 bis 20	160	50 Stk. / 1200 Stk.	2.85	Stk
8139354	 7 ^M 640344 ^M 572677 ^M	14 bis 20	180	50 Stk. / 1200 Stk.	2.90	Stk
8139355	 7 ^M 640344 ^M 572950 ^M	14 bis 20	200	50 Stk. / 1200 Stk.	2.90	Stk
8139356	 7 ^M 640344 ^M 572707 ^M	14 bis 20	220	50 Stk. / 1200 Stk.	2.95	Stk

SCHALUNGSZUBEHÖR

Anschlaghalterung

Artikelnummer	EAN Code	Stahl ø mm	Wandstärke mm	Kessel / Palette	Preis CHF	ME
8139357		14 bis 20	240	50 Stk. / 1200 Stk.	2.95	Stk
8139358		14 bis 20	250	50 Stk. / 1200 Stk.	3.00	Stk
8139359		14 bis 20	300	50 Stk. / 900 Stk.	3.05	Stk
8139360		14 bis 20	350	50 Stk. / 900 Stk.	3.15	Stk
8139361		14 bis 20	400	50 Stk. / 900 Stk.	3.25	Stk
8139362		14 bis 20	450	50 Stk. / 900 Stk.	3.35	Stk
8139363		14 bis 20	500	50 Stk. / 900 Stk.	3.45	Stk



BE-WINKEL® PRONTO

- Kunststoffwinkel 16–25 cm
- Nagellaschen für Schnellmontage
- Stirnanschlag für genaue Positionierung
- Extra starke Konstruktion
- Formstabil in Wärme und Kälte
- Passend für alle gängigen Pfosten/Klemmen
- Sehr gute Standfestigkeit, kein Wackeln
- Erfüllt die EKAS6513 Richtlinie für Seitenschutzteil
- Verpackung: Kartonschachtel à 60 Stk. mit 240 Stk. Aluminiumnägeln



QR-Code klickbar

Artikelnummer	EAN Code	Deckenstärke cm	Karton / Palette	Preis CHF	ME
8138997		16 bis 25	60 Stk. / 960 Stk.	3.30	Stk



BE-WINKEL® UNIVERSAL

- Faserverstärkter Kunststoffwinkel bis Höhe 30 cm
 - Mit 15 mm Dywidag-Gewinde
 - Extra starke Konstruktion
 - Formstabil in Wärme und Kälte
 - Passend für alle gängigen Pfosten/Klemmen
 - Sehr gute Standfestigkeit, kein Wackeln
 - suva Pro Zertifikat, Baumuster Bescheinigung 4712/4742
 - Geprüft nach EN 13374:2004
- Verpackung: Kartonschachtel à 60 Stk. mit 240 Stk. Aluminiumnägeln



QR-Code klickbar

Artikelnummer	EAN Code	Ausführung	Karton / Palette	Preis CHF	ME
8138999	7 640344 572431	ohne Gewinde	60 Stk. / 960 Stk.	3.60	Stk



BE-WINKEL® Zembord UNIVERSAL

- Mit dem Zembord Winkel wird ein passgenauer Fugenstoss erstellt
- Bestehend aus 1 Winkel, 2 Rondo und 6 Aluminiumnägeln
- Geeignet für Bodenplatten und Decken
- Ebenfalls für Wandschalungen geeignet
- Faserverstärkter Kunststoffwinkel
- Durch das T-Profil kann das Zembord optimal gehalten werden
- Verpackung: einzeln erhältlich (Pal. à 465 Stück)
- Höhe für Zembordhöhen von 25 - 28 cm



QR-Code klickbar

Artikelnummer	EAN Code	Für Zembord Höhe cm	Palette	Preis CHF	ME
8170709	7 640425 413929	25 bis 28	465 Stk.	3.30	Stk
8170710	7 640425 413936	18 bis 24	465 Stk.	3.30	Stk
8170713	7 640425 413967	ab 30	465 Stk.	3.30	Stk

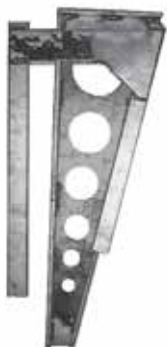

Klemmwerkzeug

- Be-Fix® Klemmwerkzeuge haben einen Klemmbereich bis 55mm
- Das Schal Brett wird nur geklemmt (kein bohren notwendig)
- Einzelstücke erhältlich
- Immer wieder einsetzbar
- Feuerverzinkt
- Passend auf alle gängigen Winkel
- Für Bretter bis 55 mm
- Äusserst stabile Konstruktion
- Keine abstehenden Teile

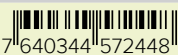

QR-Code klickbar

Artikelnummer	EAN Code	Ausführung	Palette	Preis CHF	ME
8139000	 7 ⁶⁴⁰³⁴⁴ 572448	Feuerverzinkt	100 Stk.	52.00	Stk



Seitenschutzpfosten

- Be-Fix® Seitenschutzpfosten hat eine Höhe von 1.30 Meter
- Geschlossenes Bretthalteprofil
- Einzelstücke erhältlich
- Immer wieder einsetzbar
- Feuerverzinkt
- Passend auf alle gängigen Winkel
- Geschlossene Konstruktion
- Sehr stabile Konstruktion

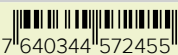

QR-Code klickbar

Artikelnummer	EAN Code	Ausführung	Palette	Preis CHF	ME
8139001	 7 ⁶⁴⁰³⁴⁴ 572455	Feuerverzinkt	100 Stk.	36.00	Stk

Transportbehälter



- Be-Fix® Transportbehälter
 - Feuerverzinkt
 - Perfekte Lagerung der Klemmwerkzeuge und Seitenschutzpfosten
- Fassungsvermögen:
- 100 Klemmwerkzeuge
 - 100 Seitenschutzpfosten



QR-Code klickbar

Artikelnummer	EAN Code	Ausführung	Preis CHF	ME
8139002	 7 640344 572462	Feuerverzinkt	825.00	Stk

Gewindestahl 15/17mm



- Gewindestahl warmgewalzt 15/17
- Tragkraft 90 kN
- Strecklast 159 kN
- Bruchlast 195 kN
- Schweissbar / roh



QR-Code klickbar

Artikelnummer	EAN Code	zulässige Last k	Länge m	Ausführung	Bund	Preis CHF	ME
8139256	 7 640344 576286	90	6	roh	100 Stk.	7.40	m

Gewindestahl 15/17mm verzinkt



- Gewindestahl warmgewalzt 15/17
- Tragkraft 90 kN
- Strecklast 159 kN
- Bruchlast 195 kN
- Schweissbar / verzinkt



QR-Code klickbar

Artikelnummer	EAN Code	zulässige Last kN	Länge m	Ausführung	Bund	Preis CHF	ME
8139257		90	6	roh	100 Stk.	8.50	m

Wassersperre G65



- Wassersperre mit Dywidag Gewinde
- Rohschwarz
- Mit Faserbeton- oder Kunststoff-Rohr kombinierbar
- Keine durchgängige Bindstelle
- Tragkraft 90 kN
- Verpackung: Reissfeste Jute-Säcke



QR-Code klickbar

Artikelnummer	EAN Code	ø mm	Karton / Palette	Preis CHF	ME
8139106		15	50 Stk. / 2000 Stk.	6.50	Stk

Beton- und Felsanker

- Beton- und Felsanker mit Dywidag-Gewinde (15 mm)
- Geeignet für Verankerungen von Dywidagstäben
- Bohrloch Ø 34 - 37 mm (roh)
- Vielseitig einsetzbar
- Verpackung: Kartonschachteln à 50 Stück



QR-Code klickbar

Artikelnummer	EAN Code	ø mm	Karton / Palette	Preis CHF	ME
8139107	 7 640344 571564	34 bis 37	50 Stk. / 2000 Stk.	7.50	Stk

Ankerplatte

- Unterlagsplatte roh
- Für Gewindestahl 15/17 mm
- Verpackung: Reissfeste Jute-Säcke

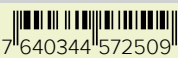

QR-Code klickbar

Artikelnummer	EAN Code	Abmessung B mm	Abmessung A mm	Abmessung C mm	Sack	Preis CHF	ME
8139681	 7 640344 572509	120	120	10	25 Stk.	7.40	Stk



Fixanker für Gewinde

- Fixanker für Gewindestahl 15/17
- Abmessungen 100x70mm
- Material roh

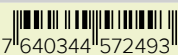

QR-Code klickbar

Artikelnummer	EAN Code	Farbe	Gewinde	Sack	Preis CHF	ME
8139682	 7 640344 572493	schwarz	15/17mm	50 Stk.	6.70	Stk



Kupplung

- Kupplung für wasserdichte Bindstellen
- Passend zu Wassersperre G65
- Verpackung: Plastiksack à 2'500 Stk.



QR-Code klickbar

Artikelnummer	EAN Code	Typ	Sack / Palette	Preis CHF	ME
8139684	 7 640344 577276	N	2'500 Stk. / 30'000 Stk.	95.00	1000



Flügelmutter

- Flügelmütter 2-flügelig, für Gewinde 15/17mm
- Verzinkt
- Verpackung: Sack à 50 Stk.



QR-Code klickbar

Artikelnummer	EAN Code	Ø Gewinde mm	Sack	Preis CHF	ME
8139678	 7 640344 572516	15/17	50 Stk.	3.45	Stk



Kalottenplatte

- Flügelmütter 2-flügelig, für Gewinde 15/17mm
- Verzinkt
- Verpackung: Sack à 50 Stk.



QR-Code klickbar

Artikelnummer	EAN Code	Platte	Ø Gewinde mm	Preis CHF	ME
8139811	 7 640425 413745	120x120x10 mm	15/17	16.80	Stk



Sechskantmutter

- Sechskantmutter für Gewinde 15/17mm
- Länge = 50 mm, Schlüsselweite 30 mm, roh
- Schweissbar
- Verpackung: Sack à 100 Stk.

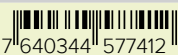

QR-Code klickbar

Artikelnummer	EAN Code	Farbe	Ø Gewinde mm	Sack	Preis CHF	ME
8139683	 7 ⁶⁴⁰³⁴⁴ 577412	schwarz	15/17	100 Stk.	3.00	Stk



Tellermutter

- Tellermutter, für Gewinde 15/17mm
- Verzinkt
- Verpackung: Sack à 50 Stk.

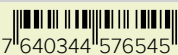

QR-Code klickbar

Artikelnummer	EAN Code	Ø Gewinde mm	Sack / Palette	Preis CHF	ME
8139679	 7 ⁶⁴⁰³⁴⁴ 576545	15/17	50 Stk. / 2'500 Stk.	8.45	Stk



QR-Code klickbar

Verbindungs-muffe

- Verbindungs-muffe für Gewinde 15/17 mm
- Länge = 100 mm
- Schlüsselweite 30 mm
- Ausführung: verzinkt
- Verpackung: Sack à 50 Stk

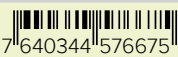

Artikelnummer	EAN Code	Schlüsselweite	Länge	Sack	Preis CHF	ME
8139680	 7 ⁶⁴⁰³⁴⁴ 576675	30mm	100mm	50 Stk.	6.90	Stk

Holz-dreikant-leisten

- Holz-Dreikant zur Herstellung von Sichtkanten
- Optimale Holzqualität für schöne Sichtkanten
- Länge 2.50 Meter



QR-Code klickbar

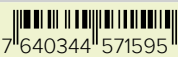
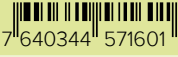
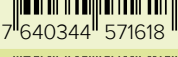
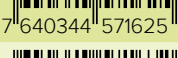
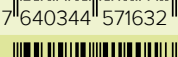
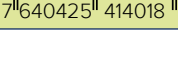

Artikelnummer	EAN Code	Länge m	Abmessung mm	Bund / Palette	Preis CHF	ME
9096979	 7 ⁶⁴⁰³⁴⁴ 571595	2.5	10	100 m / 10000 m	31.00	100
8139305	 7 ⁶⁴⁰³⁴⁴ 571601	2.5	15	100 m / 10000 m	31.00	100
9096981	 7 ⁶⁴⁰³⁴⁴ 571618	2.5	20	100 m / 5000 m	55.00	100
8139307	 7 ⁶⁴⁰³⁴⁴ 571625	2.5	25	100 m / 3000 m	83.00	100
9096984	 7 ⁶⁴⁰³⁴⁴ 571632	2.5	30	100 m / 3000 m	127.00	100
	 7 ⁶⁴⁰⁴²⁵ 414018	2.5	50	50 m / 1500 m	395.00	100

SCHALUNGSZUBEHÖR

Schalungsprofile

Artikelnummer	EAN Code	Länge m	Abmessung mm	Bund / Palette	Preis CHF	ME
8139308	 7 640425 414001	2.5	40	50 m / 1500 m	320.00	100

Dreikantleisten mit Nagelfahne

- Aus hochwertigem Kunststoff
- Für nötige Anpassungen gut sägbar
- Die Fahne ist gut nagelbar
- Mehrmals einsetzbar
- Länge: 2.50 Meter

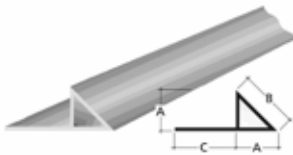

QR-Code klickbar

Artikelnummer	EAN Code	Abmessung B mm	Abmessung A mm	Abmessung C mm	Bund / Palette	Preis CHF	ME
8139397	 7 640344 573162	11	7	23	100 m / 6000 m	88.00	100

Dreikantleisten mit Nagelfahne hohl

- Aus hochwertigem Kunststoff
- Für nötige Anpassungen gut sägbar
- Die Fahne ist gut nagelbar
- Mehrmals einsetzbar
- Länge: 2.50 Meter

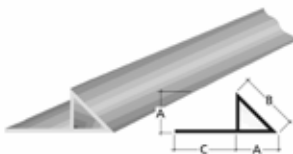

QR-Code klickbar

Artikelnummer	EAN Code	Abmessung B mm	Abmessung A mm	Abmessung C mm	Bund / Palette	Preis CHF	ME
8139398	 7 640344 573179	15	11	23	100 m / 5000 m	82.00	100





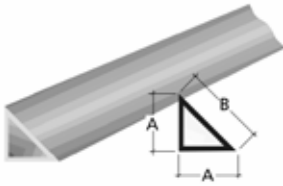

Dreikantleisten hohl aus Kunststoff

- aus hochwertigem Kunststoff
- für nötige Anpassungen gut sägbar
- mehrmals einsetzbar
- Länge: 2.50 Meter



QR-Code klickbar

Artikelnummer	EAN Code	Abmessung B mm	Abmessung A mm	Abmessung C mm	Bund / Palette	Preis CHF	ME
8139399	 7 640344 573193	10	10	15	100 m / 6500 m	52.00	100
8139400	 7 640344 573209	15	15	21	100 m / 5400 m	59.00	100
8139401	 7 640344 573216	20	20	28	100 m / 4900 m	88.00	100
8139402	 7 640344 573223	25	25	35	50 m / 2450 m	165.00	100
8139403	 7 640344 573230	30	30	40	50 m / 2400 m	195.00	100

Dreikantleisten hohl mit Steg aus Kunststoff

- aus hochwertigem Kunststoff
- für nötige Anpassungen gut sägbar
- mehrmals einsetzbar
- Länge: 2.50 Meter

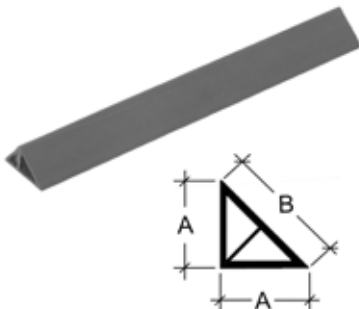

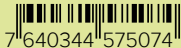

QR-Code klickbar

Artikelnummer	EAN Code	Abmessung A mm	Abmessung A mm	Abmessung B mm	Bund / Palette	Preis CHF	ME
8139565	 7 640344 575081	15	15	21	100 m / 5400 m	90.00	100
8139564	 7 640344 575074	20	20	28	100 m / 4900 m	120.00	100

SCHALUNGSZUBEHÖR

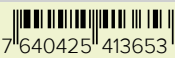
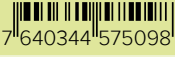
Schalungsprofile

Artikelnummer	EAN Code	Abmessung A mm	Abmessung A mm	Abmessung B mm	Bund / Palette	Preis CHF	ME
8139809	 7 ⁶⁴⁰⁴²⁵ 413653	25	25	35	50 m / 2450 m	160.00	100
8139566	 7 ⁶⁴⁰³⁴⁴ 575098	30	30	40	50 m / 2400 m	320.00	100
8139808	 7 ⁶⁴⁰⁴²⁵ 413646	40	40	58	50 m / 2100 m	410.00	100



Holz Trapezleisten

- Länge 2.50 Meter / Stk.
- Standardmässig aus Weichholz
- Astreines Holz

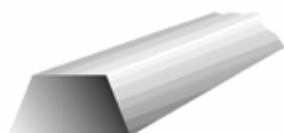

QR-Code klickbar

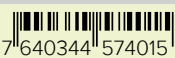

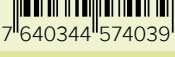
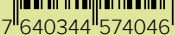
Artikelnummer	EAN Code	Abmessung B mm	Abmessung A mm	Abmessung C mm	Bund / Palette	Preis CHF	ME
8139464	 7 ⁶⁴⁰³⁴⁴ 574015	10	15	15	100 m / 3000 m	230.00	100
8139465	 7 ⁶⁴⁰³⁴⁴ 574022	15	20	10	100 m / 3000 m	175.00	100
8139466	 7 ⁶⁴⁰³⁴⁴ 574039	13	22	13	100 m / 3000 m	175.00	100
8139467	 7 ⁶⁴⁰³⁴⁴ 574046	21	28	9	100 m / 3000 m	210.00	100

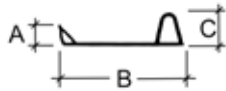
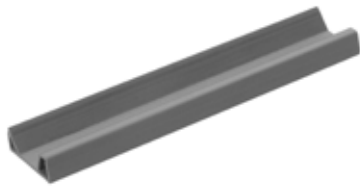

Abtropfprofil aus Kunststoff

- Aus hochwertigem Kunststoff
- Für nötige Anpassungen gut sägbar
- Das Ausschalen geht schneller und leichter
- Länge: 2.50 Meter



QR-Code klickbar

Artikelnummer	EAN Code	Abmessung B mm	Abmessung A mm	Abmessung C mm	Bund / Palette	Preis CHF	ME
8139404	7 640344 573247	31	10	10	100 m / 5000 m	220.00	100

Wassernasen aus Kunststoff

- Aus hochfestem Kunststoff
- Für nötige Anpassungen gut sägbar
- Einfaches Ausschalen
- Länge: 2.50 Meter

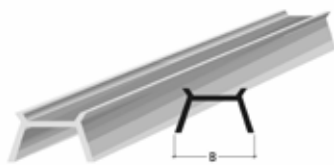

QR-Code klickbar

Artikelnummer	EAN Code	Abmessung mm	Bund / Palette	Preis CHF	ME
8139406	7 640344 573261	10	100 m / 4900 m	86.00	100
8139405	7 640344 573254	12	100 m / 5600 m	72.00	100

Betonhülse aus Edelstahl



- Ankerhülse in 1.4301 für Dywidag Ø 15mm
- Korrosionsbeständig
- Einfache Handhabung
- Bruchlast bei 75 kN (Dywidag gerollt)
- Lieferung mit Konus und Verschluss-Stopfen
- Inklusive Nagel vorgesteckt
- Kunststoffeimer à 100 Stück
- Verpackung: Kunststoffeimer mit Haltegriff (100% recyclebar)

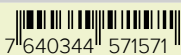

QR-Code klickbar

Artikelnummer	EAN Code	ø mm	Kessel / Palette	Preis CHF	ME
8139108	 7 640344 571571	15	100 Stk. / 2400 Stk.	5.40	Stk

Betonhülse aus Kunststoff



- Kostengünstige Beschaffung
- Einfaches handling auf der Baustelle
- Lieferung mit Konus (Nagel vorgesteckt)
- Inklusive Verschluss-Stopfen nach dem ausschalen
- Kunststoffeimer à 100 Stück
- Verpackung: Kunststoffeimer mit Haltegriff (100% recyclebar)



QR-Code klickbar

Artikelnummer	EAN Code	ø mm	Kessel / Palette	Preis CHF	ME
8139109	 7 640344 571588	15	100 Stk. / 2400 Stk.	3.10	Stk



Zembord

- Einfache und leichte Montage auf der Baustelle
- Keine Nachbehandlung erforderlich
- Schubverzahnung der Arbeitsfuge
- Kein Ausschalen, kein Ausbluten bei den Anschlussaschen
- Stossverbindungen für Stabbewehrung
- Kombination mit Arbeitsfugenband möglich
- Für Wände, Bodenplatten und Decken geeignet
- Schubfestigkeit nach SIA 262:213, 4.34.3.2 gewährleistet



QR-Code klickbar

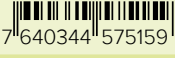
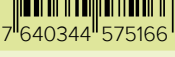
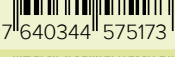
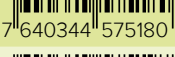
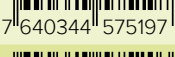
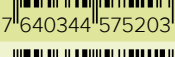
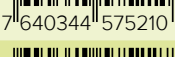
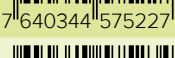
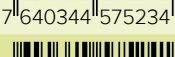
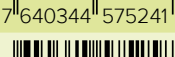
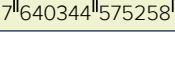

Artikelnummer	EAN Code	Länge cm	Höhe mm	Palette	Preis CHF	ME
8139624	 7 ⁶⁴⁰³⁴⁴ 575135	110	180	38.50 m	15.00	m
8139625	 7 ⁶⁴⁰³⁴⁴ 575142	110	200	38.50 m	16.00	m
8139626	 7 ⁶⁴⁰³⁴⁴ 575159	110	220	38.50 m	18.00	m
8139627	 7 ⁶⁴⁰³⁴⁴ 575166	110	240	38.50 m	20.00	m
8139628	 7 ⁶⁴⁰³⁴⁴ 575173	110	250	38.50 m	20.00	m
8139629	 7 ⁶⁴⁰³⁴⁴ 575180	110	280	38.50 m	23.00	m
8139630	 7 ⁶⁴⁰³⁴⁴ 575197	110	300	38.50 m	25.00	m
8139631	 7 ⁶⁴⁰³⁴⁴ 575203	110	320	38.50 m	26.00	m
8139632	 7 ⁶⁴⁰³⁴⁴ 575210	110	350	38.50 m	29.00	m
8139633	 7 ⁶⁴⁰³⁴⁴ 575227	110	400	38.50 m	33.00	m
8139634	 7 ⁶⁴⁰³⁴⁴ 575234	110	420	38.50 m	37.00	m
8139635	 7 ⁶⁴⁰³⁴⁴ 575241	110	450	38.50 m	37.00	m
8139636	 7 ⁶⁴⁰³⁴⁴ 575258	110	500	38.50 m	42.00	m















Zembord WD-F

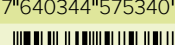
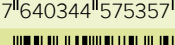
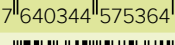
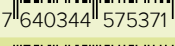
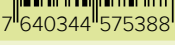
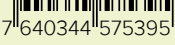





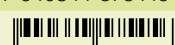

- Ermöglicht das Abschalen von wasserdichten Arbeitsfugen
- Geeignet für Fugenband
- Das Ausschalen entfällt
- Kann bei sämtlichen Arbeitsfugen eingesetzt werden
- Schubfestigkeit nach SIA 262:213, 4.34.3.2 gewährleistet
- Einfache und leichte Montage auf der Baustelle
- Keine Nachbehandlung erforderlich
- Stossverbindungen für Stabbewehrung
- Für Wände, Bodenplatten und Decken geeignet

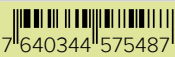
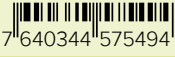
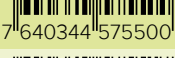
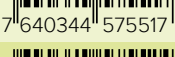
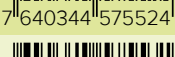
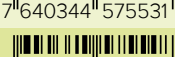
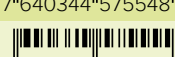

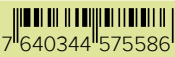
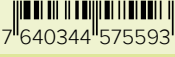
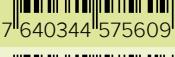
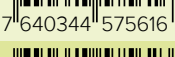
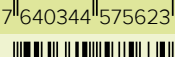
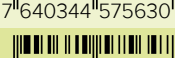
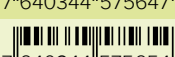
QR-Code klickbar

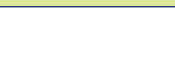
Artikelnummer	EAN Code	Länge cm	Höhe mm	Palette	Preis CHF	ME
8139259	 7 ⁶⁴⁰³⁴⁴ 575296	110	200	38.50 m	50.00	m
8139260	 7 ⁶⁴⁰³⁴⁴ 575302	110	240	38.50 m	50.00	m
8139261	 7 ⁶⁴⁰³⁴⁴ 575319	110	250	38.50 m	50.00	m
8139262	 7 ⁶⁴⁰³⁴⁴ 575326	110	260	38.50 m	51.00	m
8139263	 7 ⁶⁴⁰³⁴⁴ 575333	110	270	38.50 m	51.00	m
8139264	 7 ⁶⁴⁰³⁴⁴ 575340	110	280	38.50 m	52.00	m
8139265	 7 ⁶⁴⁰³⁴⁴ 575357	110	290	38.50 m	53.00	m
8139266	 7 ⁶⁴⁰³⁴⁴ 575364	110	300	38.50 m	54.00	m
8139267	 7 ⁶⁴⁰³⁴⁴ 575371	110	310	38.50 m	55.00	m
8139268	 7 ⁶⁴⁰³⁴⁴ 575388	110	320	38.50 m	56.00	m
8139269	 7 ⁶⁴⁰³⁴⁴ 575395	110	330	38.50 m	57.00	m
8139270	 7 ⁶⁴⁰³⁴⁴ 575401	110	340	38.50 m	58.00	m
8139271	 7 ⁶⁴⁰³⁴⁴ 575418	110	350	38.50 m	59.00	m
8139272	 7 ⁶⁴⁰³⁴⁴ 575425	110	360	38.50 m	59.00	m
8139273	 7 ⁶⁴⁰³⁴⁴ 575432	110	370	38.50 m	60.00	m
8139274	 7 ⁶⁴⁰³⁴⁴ 575449	110	380	38.50 m	61.00	m
8139275	 7 ⁶⁴⁰³⁴⁴ 575456	110	390	38.50 m	62.00	m
8139286	 7 ⁶⁴⁰³⁴⁴ 575463	110	400	38.50 m	63.00	m
8139287	 7 ⁶⁴⁰³⁴⁴ 575470	110	410	38.50 m	64.00	m

Artikelnummer	EAN Code	Länge cm	Höhe mm	Palette	Preis CHF	ME
8139288	 7 640344 575487	110	420	38.50 m	65.00	m
8139289	 7 640344 575494	110	430	38.50 m	66.00	m
8139290	 7 640344 575500	110	440	38.50 m	67.00	m
8139291	 7 640344 575517	110	450	38.50 m	67.00	m
8139292	 7 640344 575524	110	460	38.50 m	68.00	m
8139293	 7 640344 575531	110	470	38.50 m	69.00	m
8139294	 7 640344 575548	110	480	38.50 m	70.00	m
8139295	 7 640344 575555	110	490	38.50 m	71.00	m
8139296	 7 640344 575562	110	500	38.50 m	72.00	m
8139297	 7 640344 575579	110	510	38.50 m	73.00	m
8139505	 7 640344 575586	110	520	38.50 m	74.00	m
8139568	 7 640344 575593	110	530	38.50 m	75.00	m
8139569	 7 640344 575609	110	540	38.50 m	75.00	m
8139570	 7 640344 575616	110	550	38.50 m	76.00	m
8139571	 7 640344 575623	110	560	38.50 m	77.00	m
8139572	 7 640344 575630	110	570	38.50 m	78.00	m
8139573	 7 640344 575647	110	580	38.50 m	79.00	m
8139574	 7 640344 575654	110	590	38.50 m	80.00	m
8139575	 7 640344 575661	110	600	38.50 m	81.00	m











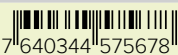
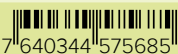
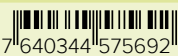
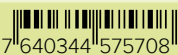
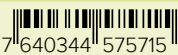
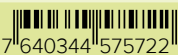
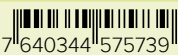
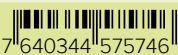
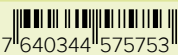
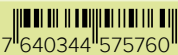
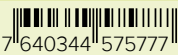

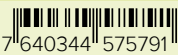

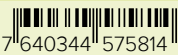

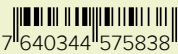

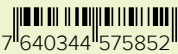
Zembord WD-P

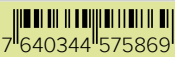
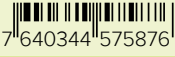
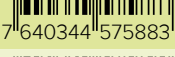
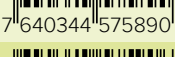
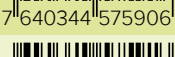
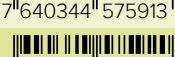
- Ermöglicht das Abschalen von wasserdichten Arbeitsfugen
- Geeignet für Fugenblech
- Das Ausschalen entfällt
- Kann bei sämtlichen Arbeitsfugen eingesetzt werden
- Schubfestigkeit nach SIA 262:213, 4.34.3.2 gewährleistet
- Einfache und leichte Montage auf der Baustelle
- Keine Nachbehandlung erforderlich
- Stossverbindungen für Stabbewehrung
- Für Wände, Bodenplatten und Decken geeignet

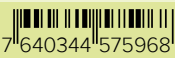
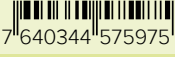
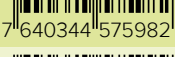
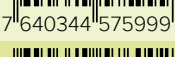
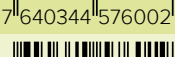
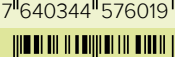
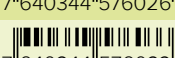

QR-Code klickbar

Artikelnummer	EAN Code	Länge cm	Höhe mm	Palette	Preis CHF	ME
8139576	 7 ⁶⁴⁰³⁴⁴ 575678	110	200	38.50 m	50.00	m
8139577	 7 ⁶⁴⁰³⁴⁴ 575685	110	250	38.50 m	50.00	m
8139578	 7 ⁶⁴⁰³⁴⁴ 575692	110	260	38.50 m	51.00	m
8139579	 7 ⁶⁴⁰³⁴⁴ 575708	110	270	38.50 m	51.00	m
8139580	 7 ⁶⁴⁰³⁴⁴ 575715	110	280	38.50 m	52.00	m
8139582	 7 ⁶⁴⁰³⁴⁴ 575722	110	290	38.50 m	53.00	m
8139583	 7 ⁶⁴⁰³⁴⁴ 575739	110	300	38.50 m	54.00	m
8139584	 7 ⁶⁴⁰³⁴⁴ 575746	110	310	38.50 m	55.00	m
8139585	 7 ⁶⁴⁰³⁴⁴ 575753	110	320	38.50 m	56.00	m
8139586	 7 ⁶⁴⁰³⁴⁴ 575760	110	330	38.50 m	57.00	m
8139587	 7 ⁶⁴⁰³⁴⁴ 575777	110	340	38.50 m	58.00	m
8139588	 7 ⁶⁴⁰³⁴⁴ 575784	110	350	38.50 m	59.00	m
8139589	 7 ⁶⁴⁰³⁴⁴ 575791	110	360	38.50 m	59.00	m
8139590	 7 ⁶⁴⁰³⁴⁴ 575807	110	370	38.50 m	60.00	m
8139591	 7 ⁶⁴⁰³⁴⁴ 575814	110	380	38.50 m	61.00	m
8139592	 7 ⁶⁴⁰³⁴⁴ 575821	110	390	38.50 m	62.00	m
8139593	 7 ⁶⁴⁰³⁴⁴ 575838	110	400	38.50 m	63.00	m
8139594	 7 ⁶⁴⁰³⁴⁴ 575845	110	410	38.50 m	64.00	m
8139595	 7 ⁶⁴⁰³⁴⁴ 575852	110	420	38.50 m	65.00	m

Artikelnummer	EAN Code	Länge cm	Höhe mm	Palette	Preis CHF	ME
8139596	 7 640344 575869	110	430	38.50 m	66.00	m
8139597	 7 640344 575876	110	440	38.50 m	67.00	m
8139598	 7 640344 575883	110	450	38.50 m	67.00	m
8139599	 7 640344 575890	110	460	38.50 m	68.00	m
8139600	 7 640344 575906	110	470	38.50 m	69.00	m
8139601	 7 640344 575913	110	480	38.50 m	70.00	m
8139602	 7 640344 575920	110	490	38.50 m	71.00	m
8139603	 7 640344 575937	110	500	38.50 m	72.00	m
8139604	 7 640344 575944	110	510	38.50 m	73.00	m
8139605	 7 640344 575951	110	520	38.50 m	74.00	m
8139606	 7 640344 575968	110	530	38.50 m	75.00	m
8139607	 7 640344 575975	110	540	38.50 m	75.00	m
8139608	 7 640344 575982	110	550	38.50 m	76.00	m
8139609	 7 640344 575999	110	560	38.50 m	77.00	m
8139610	 7 640344 576002	110	570	38.50 m	78.00	m
8139611	 7 640344 576019	110	580	38.50 m	79.00	m
8139612	 7 640344 576026	110	590	38.50 m	80.00	m
8139613	 7 640344 576033	110	600	38.50 m	81.00	m
8139614	 7 640344 576040	110	750	38.50 m	109.00	m
8139615	 7 640344 576057	110	1000	38.50 m	158.00	m



Zembord Winkel WD

- Enorme Zeit- und Kosteneinsparung
- Einfache und leichte Montage
- Höhenverstellbar
- Investitionsmaterial (immer wieder verwendbar)
- Verzinkt

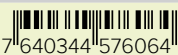

QR-Code klickbar

Artikelnummer	EAN Code	Höhe mm	Preis CHF	ME
8139659	 7 ⁶⁴⁰³⁴⁴ 576064	bis 500	52.00	Stk







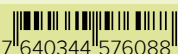

Zembord WD-I

- Ermöglicht das Abschalen von wasserdichten Arbeitsfugen
- Geeignet für Injektionsschlauch
- Das Ausschalen entfällt
- Kann bei sämtlichen Arbeitsfugen eingesetzt werden
- Schubfestigkeit nach SIA 262:213, 4.34.3.2 gewährleistet
- Einfache und leichte Montage auf der Baustelle
- Keine Nachbehandlung erforderlich
- Stossverbindungen für Stabbewehrung
- Für Wände, Bodenplatten und Decken geeignet

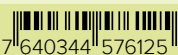

QR-Code klickbar

Artikelnummer	EAN Code	Länge cm	Höhe mm	Palette	Preis CHF	ME
8139616	 7 ⁶⁴⁰³⁴⁴ 576071	110	250	38.50 m	50.00	m
8139617	 7 ⁶⁴⁰³⁴⁴ 576088	110	300	38.50 m	54.00	m
8139618	 7 ⁶⁴⁰³⁴⁴ 576095	110	350	38.50 m	59.00	m
8139619	 7 ⁶⁴⁰³⁴⁴ 576101	110	400	38.50 m	63.00	m
8139620	 7 ⁶⁴⁰³⁴⁴ 576118	110	450	38.50 m	67.00	m
8139621	 7 ⁶⁴⁰³⁴⁴ 576125	110	500	38.50 m	72.00	m

Artikelnummer	EAN Code	Länge cm	Höhe mm	Palette	Preis CHF	ME
8139622		110	550	38.50 m	76.00	m
8139623		110	600	38.50 m	81.00	m



RONDO light

- Aus hochwertigem Kunststoff
- Aussenseitiges sperren des Zembords
- Mit vorgestecktem Aluminiumnagel
- Verpackung: Transparente Säcke à 500 Stk.



QR-Code klickbar

Artikelnummer	EAN Code	Typ	Sack	Preis CHF	ME
8139581		50 light	500 Stk.	45.00	100











Rapidobord

Die richtige Abschalung mit Bewehrungsdurchdringung und für raue Betonoberfläche

- Die Rasterung mit 5 cm-Abständen passt sich allen Bewehrungsteilungen an
- RAPIDOBORD® W passt sich fast jedem Radius an
- Guter Verbund zum Neubeton wird durch den Waschbeton-Effekt erzielt
- RAPIDOBORD® W erzeugt eine raue Oberfläche



QR-Code klickbar

Artikelnummer	EAN Code	Länge cm	Höhe mm	Palette / Bund	Preis CHF	ME
8139637	 7 ⁶⁴⁰⁴²⁵ 411185	250	200	500 m / 25 m	11.00	m
8139638	 7 ⁶⁴⁰⁴²⁵ 411192	250	250	500 m / 25 m	12.00	m
8139639	 7 ⁶⁴⁰⁴²⁵ 411208	250	300	500 m / 25 m	13.00	m
8139640	 7 ⁶⁴⁰⁴²⁵ 411215	250	350	500 m / 25 m	14.00	m
8139641	 7 ⁶⁴⁰⁴²⁵ 411222	250	400	250 m / 12.5 m	15.00	m
8139642	 7 ⁶⁴⁰⁴²⁵ 411239	250	450	250 m / 12.5 m	16.00	m
8139643	 7 ⁶⁴⁰⁴²⁵ 411246	250	500	250 m / 12.5 m	17.00	m
8139644	 7 ⁶⁴⁰⁴²⁵ 411260	250	600	250 m / 25 m	25.00	m

DIVERSE BAUPRODUKTE

	Montageplatten	104
	Holzkeile	107
	Drahtstifte	108
	Kunststoffnagel	109
	Schachtleitern	110



Unterlagsplatten Typ V



- Druckfeste Montagehilfe
- Aus hochfestem Kunststoff
- Für die Montage von Betonfertigteilen
- Nicht für dauerhafte Fixierung geeignet
- Verpackung: Transparente Säcke

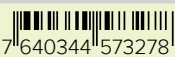

QR-Code klickbar

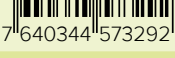
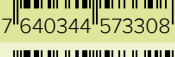
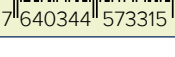
Artikelnummer	EAN Code	Dicke mm	Länge mm	Sack / Palette	Preis CHF	ME
<u>8139407</u>	 7 ⁶⁴⁰³⁴⁴ 573278	2	70	10000 Stk. / 40000 Stk.	100.00	1000
<u>8139408</u>	 7 ⁶⁴⁰³⁴⁴ 573285	3	70	10000 Stk. / 40000 Stk.	135.00	1000
<u>8139409</u>	 7 ⁶⁴⁰³⁴⁴ 573292	4	70	500 Stk. / 20000 Stk.	175.00	1000
<u>8139410</u>	 7 ⁶⁴⁰³⁴⁴ 573308	5	70	500 Stk. / 20000 Stk.	205.00	1000
<u>8139411</u>	 7 ⁶⁴⁰³⁴⁴ 573315	6	70	500 Stk. / 20000 Stk.	260.00	1000

Artikelnummer	EAN Code	Dicke mm	Länge mm	Sack / Palette	Preis CHF	ME
8139412		7	70	500 Stk. / 20000 Stk.	345.00	1000
8139413		8	70	250 Stk. / 10000 Stk.	365.00	1000
8139414		9	70	250 Stk. / 10000 Stk.	395.00	1000
8139415		10	70	250 Stk. / 10000 Stk.	435.00	1000
8139416		15	70	200 Stk. / 8000 Stk.	1'090.00	1000
8139417		20	70	150 Stk. / 6000 Stk.	1'400.00	1000
8139418		25	70	150 Stk. / 6000 Stk.	1'720.00	1000
8139419		30	70	150 Stk. / 6000 Stk.	2'120.00	1000







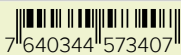

Unterlagsplatten mit Schlitz

- Druckfeste Montagehilfe
- Mit mittigem Schlitz
- Aus hochfestem Kunststoff
- Für die Montage von Betonfertigteilen
- Nicht für dauerhafte Fixierung geeignet
- Verpackung: Transparente Säcke

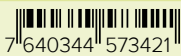

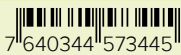

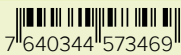
QR-Code klickbar

Artikelnummer	EAN Code	Dicke mm	Länge mm	Schlitz länge mm	Karton / Palette	Preis CHF	ME
8139420		1	60	13	1700 Stk. / 51000 Stk.	180.00	1000
8139421		2	70	22	250 Stk. / 40000 Stk.	95.00	1000
8139422		3	70	22	250 Stk. / 4000 Stk.	120.00	1000
8139423		5	70	22	125 Stk. / 20000 Stk.	185.00	1000
8139424		7	70	22	125 Stk. / 20000 Stk.	310.00	1000
8139425		8	70	22	125 Stk. / 10000 Stk.	350.00	1000
8139426		10	70	22	125 Stk. / 10000 Stk.	395.00	1000

DIVERSE BAUPRODUKTE

Montageplatten

Artikelnummer	EAN Code	Dicke mm	Länge mm	Schlitz länge mm	Karton / Palette	Preis CHF	ME
8139427	 7 640344 573476	15	70	22	50 Stk. / 8000 Stk.	950.00	1000
8139428	 7 640344 573483	20	70	22	50 Stk. / 6000 Stk.	1'290.00	1000







Distanzplatten

- Druckfeste Montagehilfe
- Aus hochfestem Kunststoff
- Für die Montage von Betonfertigteilen
- Nicht für dauerhafte Fixierung geeignet
- Verpackung: Transparente Säcke



QR-Code klickbar

Artikelnummer	EAN Code	Dicke mm	Abmessung mm	Sack	Preis CHF	ME
8139429	 7 640344 573490	2	50x70	500 Stk.	100.00	1000
8139430	 7 640344 573506	3	50x70	500 Stk.	140.00	1000
8139431	 7 640344 573513	5	50x70	500 Stk.	210.00	1000
8139432	 7 640344 573520	10	50x70	500 Stk.	280.00	1000
8139433	 7 640344 573537	20	50x70	250 Stk.	595.00	1000

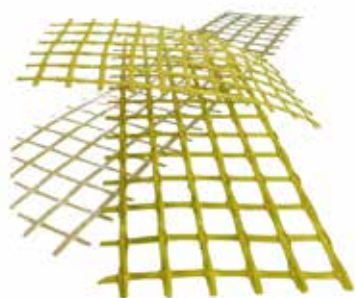

Mauerwerksarmierung

- Mauerwerksbewehrung
- Aus stabilem Glasfasergeflecht
- Es werden die Rissbildungen minimiert
- Es stärkt das Mauerwerk
- Schnelle und einfache Montage
- Keine Schallübertragung
- Verpackung: in praktischen Rollen-Spendern

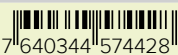

QR-Code klickbar

Artikelnummer	EAN Code	Bandbreite mm	Rolle	Preis CHF	ME
8139258	 7 ^M 640344 ^M 574428 ^M	85 in Rollen	100 m	4.20	m







Holzkeile Hart

- Hartholz-Keile
- Holzart: Buche aus Europa
- Hohe Stabilität
- Verpackung: Stabile Geflecht-Säcke

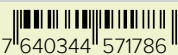

QR-Code klickbar

Artikelnummer	EAN Code	Breite mm	Länge mm	Höhe mm	Sack / Palette	Preis CHF	ME
8139309	 7 ^M 640344 ^M 571786 ^M	60	180	24	200 Stk. / 2400 Stk.	24.00	100
8139310	 7 ^M 640344 ^M 571793 ^M	80	180	24	150 Stk. / 1800 Stk.	36.00	100
9089733	 7 ^M 640425 ^M 414810 ^M	100	180	24	150 Stk. / 1800 Stk.	36.00	100
9089734	 7 ^M 640425 ^M 414827 ^M	100	200	38	80 Stk. / 960 Stk.	84.00	100
9089735	 7 ^M 640425 ^M 414834 ^M	120	200	38	60 Stk. / 720 Stk.	100.00	100
8139311	 7 ^M 640344 ^M 571809 ^M	80	200	38	100 Stk. / 1200 Stk.	55.60	100

Drahtstifte Standard

- Drahtstifte nach DIN 1151 A/B
- Blanke Oberfläche
- Flachkopf
- Werkstoff Stahl
- Verpackung: In Kartonschachteln



QR-Code klickbar



Artikelnummer	EAN Code	ø mm	Länge mm	Karton / Palette	Preis CHF	ME	
8139668	7 640344 577344	1.6	30	1 kg / 500 kg	4.50	kg	
8188779	7 640425 413875	2.5	60	8x2.5kg Folie	8 x 2.5 kg / 720 kg	1.85	kg
8139804	7 640425 413578	2.8	70		8 x 2.5 kg / 720 kg	1.85	kg
8188780	7 640425 413882	3.1	80		8 x 2.5 kg / 720 kg	1.85	kg
8188781	7 640425 413899	3.4	90		8 x 2.5 kg / 720 kg	1.85	kg

Doppelkopfstifte

- Drahtstifte Stahl blank mit Doppelkopf
- Verpackung: In Kartonschachteln



QR-Code klickbar



Artikelnummer	EAN Code	ø mm	Länge mm	Karton / Palette	Preis CHF	ME
8139673	7 640425 414247	3.1	65/75		8 x 2.5 kg / 720 kg	kg
8139674	7 640425 414254	3.1	70/80		8 x 2.5 kg / 720 kg	kg



Kunststoffnagel

- Stabile Kunststoffnägels
- Für die Befestigung von Dämmplatten
- Verpackung: Transparente Säcke



QR-Code klickbar

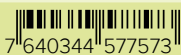

Artikelnummer	EAN Code	Länge	Sack / Palette	Preis CHF	ME
8139685	 7 ⁶⁴⁰³⁴⁴ 577542	75mm	3'000 Stk. / 60'000 Stk.	48.00	1000
8139686	 7 ⁶⁴⁰³⁴⁴ 577559	100mm	2'000 Stk. / 40'000 Stk.	36.00	1000
8139687	 7 ⁶⁴⁰³⁴⁴ 577566	125mm	1'500 Stk. / 30'000 Stk.	42.00	1000
8149006	 7 ⁶⁴⁰³⁴⁴ 577573	150mm	500 Stk. / 25'000 Stk.	62.00	1000
8139688	 7 ⁶⁴⁰³⁴⁴ 577580	175mm	250 Stk. / 22'750 Stk.	120.00	1000
8139689	 7 ⁶⁴⁰³⁴⁴ 577597	200mm	250 Stk. / 22'750 Stk.	130.00	1000
8139690	 7 ⁶⁴⁰³⁴⁴ 577603	250mm	250 Stk. / 16'000 Stk.	210.00	1000
8139691	 7 ⁶⁴⁰³⁴⁴ 577610	275mm	250 Stk. / 16'000 Stk.	230.00	1000





















Schachtleitern verzinkt

Die Schachtleitern ermöglicht einen sicheren und einfachen Einstieg.

- Normkonform nach SN EN 14396
- anhand der Zwischenstücke beliebig verlängerbar



QR-Code klickbar

Artikelnummer	EAN Code	Doppelbriden	Typ	Länge mm	Preis CHF	ME
9089689	 7 ⁶⁴⁰⁴²⁵ 415077	2	600	750	45.00	Stk
9089690	 7 ⁶⁴⁰⁴²⁵ 415084	2	900	1050	60.00	Stk
9089691	 7 ⁶⁴⁰⁴²⁵ 415091	2	1200	1350	75.00	Stk
9089692	 7 ⁶⁴⁰⁴²⁵ 415107	2	1500	1650	90.00	Stk
9089693	 7 ⁶⁴⁰⁴²⁵ 415114	2	1800	1950	105.00	Stk
9089694	 7 ⁶⁴⁰⁴²⁵ 415121	2	2100	2250	120.00	Stk
9089695	 7 ⁶⁴⁰⁴²⁵ 415138	2	2400	2550	135.00	Stk
9089698	 7 ⁶⁴⁰⁴²⁵ 415145	2	2700	2850	150.00	Stk
9089699	 7 ⁶⁴⁰⁴²⁵ 415152	2	3000	3150	165.00	Stk
9089697	 7 ⁶⁴⁰⁴²⁵ 415169	2	3300	3450	180.00	Stk
9089696	 7 ⁶⁴⁰⁴²⁵ 415176	3	3600	3750	195.00	Stk
9089700	 7 ⁶⁴⁰⁴²⁵ 415183	3	3900	4050	210.00	Stk
9089701	 7 ⁶⁴⁰⁴²⁵ 415190	3	4200		225.00	Stk
9089702	 7 ⁶⁴⁰⁴²⁵ 415206	3	4500	4650	240.00	Stk
9089703	 7 ⁶⁴⁰⁴²⁵ 415213	3	4800	4950	255.00	Stk
9089704	 7 ⁶⁴⁰⁴²⁵ 415220	3	5100	5250	270.00	Stk
9089705	 7 ⁶⁴⁰⁴²⁵ 415237	3	5400	5550	285.00	Stk
9089706	 7 ⁶⁴⁰⁴²⁵ 415244	3	5700	5850	300.00	Stk
9089707	 7 ⁶⁴⁰⁴²⁵ 415251	3	6000	6150	315.00	Stk



















Schachtleitern inox

Die Schachtleitern ermöglicht einen sicheren und einfachen Einstieg.

- Normkonform nach SN EN 14396
- anhand der Zwischenstücke beliebig verlängerbar



QR-Code klickbar

Artikelnummer	EAN Code	Doppelbriden	Typ	Länge mm	Preis CHF	ME
9089666	 7 ⁶⁴⁰⁴²⁵ 414841	2	600	750	135.00	Stk
9089667	 7 ⁶⁴⁰⁴²⁵ 414858	2	900	1050	180.00	Stk
9089668	 7 ⁶⁴⁰⁴²⁵ 414865	2	1200	1350	225.00	Stk
9089669	 7 ⁶⁴⁰⁴²⁵ 414872	2	1500	1650	270.00	Stk
9089670	 7 ⁶⁴⁰⁴²⁵ 414889	2	1800	1950	315.00	Stk
9089671	 7 ⁶⁴⁰⁴²⁵ 414896	2	2100	2250	360.00	Stk
9089672	 7 ⁶⁴⁰⁴²⁵ 414902	2	2400	2550	405.00	Stk
9089673	 7 ⁶⁴⁰⁴²⁵ 414919	2	2700	2850	450.00	Stk
9089675	 7 ⁶⁴⁰⁴²⁵ 414933	2	3000	3150	495.00	Stk
9089676	 7 ⁶⁴⁰⁴²⁵ 414940	2	3300	3450	540.00	Stk
9089677	 7 ⁶⁴⁰⁴²⁵ 414957	3	3600	3750	630.00	Stk
9089678	 7 ⁶⁴⁰⁴²⁵ 414964	3	3900	4050	675.00	Stk
9089679	 7 ⁶⁴⁰⁴²⁵ 414971	3	4200	4350	720.00	Stk
9089680	 7 ⁶⁴⁰⁴²⁵ 414988	3	4500	4650	765.00	Stk
9089681	 7 ⁶⁴⁰⁴²⁵ 414995	3	4800	4950	810.00	Stk
9089682	 7 ⁶⁴⁰⁴²⁵ 415008	3	5100	5250	855.00	Stk
9089683	 7 ⁶⁴⁰⁴²⁵ 415015	3	5400	5550	900.00	Stk
9089684	 7 ⁶⁴⁰⁴²⁵ 415022	3	5700	5850	945.00	Stk
9089685	 7 ⁶⁴⁰⁴²⁵ 415039	3	6000	6150	990.00	Stk

Doppelbriden

inkl. Schrauben und Dübel



QR-Code klickbar

Artikelnummer	EAN Code	Qualität	Preis CHF	ME
9089708	 7 640425 415268	verzinkt	20.00	Stk
9089687	 7 640425 415060	inox A4	60.00	Stk

Einsteighilfen

Fallback:



QR-Code klickbar

Artikelnummer	EAN Code	Qualität	Preis CHF	ME
9089709	 7 640425 415275	verzinkt	175.00	Stk
9089686	 7 640425 415053	inox A4	525.00	Stk

Entdecken Sie hier das komplette Angebot von ProOne

Nutzen Sie dafür ganz einfach die hier abgedruckten QR Codes pro Produktkategorie.



Dichten, Kleben und Streichen



Baustoffe



Werkzeuge



Arbeitsschutz und Bekleidung



Reinigungsmittel



Unsere Handwerkerzentren und Lager | Nos points de vente et dépôts | I nostri punti vendita e depositi

Deutschschweiz / Suisse allemande / Svizzera tedesca:

Baubedarf Richner

Transportstrasse 2
9450 Altstätten
Tel. 071 755 50 40

Blumenaustrasse 2
9320 Arbon
Tel. 071 447 70 00

Gellertstrasse 212
4052 Basel
Tel. 061 560 74 10

Luzerner Ring 65
4056 Basel
Tel. 061 381 66 70

Güterstrasse 46
3008 Bern
Tel. 031 336 60 20

Wohlerstrasse 41a
5620 Bremgarten
Tel. 056 648 23 60

Pulverhausweg 1
5033 Buchs bei Aarau
Tel. 062 834 37 80

Pulverweg 9
3400 Burgdorf
Tel. 034 420 74 10
Tel. 034 420 74 74

Industriezone Nr. 8
7408 Cazis
Tel. 081 651 14 06

Alte Steinhäuserstrasse 23
6330 Cham
Tel. 041 798 05 70

Alte Steinhäuserstrasse 27
6330 Cham
Tel. 041 741 52 24

Kalchbühlstrasse 40
7000 Chur
Tel. 081 252 13 80

Industriestrasse 18
7001 Chur
Tel. 081 286 75 50

Plaun da Diras
7180 Disentis
Tel. 081 947 44 20

Au 3
7235 Fideris
Tel. 081 300 30 80

Langfeldstrasse 52
8500 Frauenfeld
Tel. 052 721 29 17

Langfeldstrasse 108
8500 Frauenfeld
Tel. 052 723 49 49

Wolleraustrasse 15d
8807 Freienbach
Tel. 055 410 48 68

Ziegeleistrasse 13
5070 Frick
Tel. 062 865 70 80

Schächlistrasse 7
5412 Gebenstorf
Tel. 056 201 02 02
Tel. 056 201 02 07

Sägereistrasse 24
8152 Glattbrugg
Tel. 044 810 18 05

Langrütstrasse 20
9403 Goldach/SG
Tel. 071 929 96 30

Staadstrasse 80
2540 Grenchen
Tel. 032 654 82 52

Ziegeleistrasse 2
4614 Hägendorf
Tel. 062 210 12 00

Hanegg
Gehrenstegweg 2
8810 Horgen
Tel. 044 727 90 12
Tel. 044 727 90 10

Hauptstrasse 14 A
5502 Hunzenschwil
Tel. 062 889 45 00

Gstaadstrasse 41
4452 Itingen
Tel. 061 931 22 90

Eichwiesstrasse 8
8645 Jona
Tel. 055 221 11 74

Kernserstrasse 11
6056 Kägiswil
Tel. 041 368 11 00

Industriestrasse 11
Postfach
3210 Kerzers
Tel. 031 750 73 60

Dattenmattstrasse 16b
6010 Kriens
Tel. 041 317 03 20

Bern-Zürich-Strasse 40b
4900 Langenthal
Tel. 062 923 51 52
Tel. 062 919 82 82

Industriestrasse 1
8574 Lengwil
Tel. 071 688 47 47

Stelzenstrasse 30
8706 Meilen
Tel. 044 924 40 60

Industriestrasse 15
8752 Näfels
Tel. 055 612 27 80

Althardstrasse 190
8105 Regensdorf
Tel. 044 870 81 81

Am Kägenrain 1-3
Postfach 1144
4153 Reinach
Tel. 061 717 99 66

Dammstrasse 1
9532 Rickenbach bei Wil
Tel. 071 929 51 51

Riedmattstrasse 2
8153 Rümlang
Tel. 043 211 21 21

Cho d'Punt 105
7503 Samedan
Tel. 081 850 06 50

Tiefriet
7320 Sargans
Tel. 081 720 42 30

Rheinweg 7
8200 Schaffhausen
Tel. 052 624 78 95
Tel. 052 644 09 90

Lättenstrasse 39
8952 Schlieren
Tel. 044 731 01 78

Via Isla 9
7151 Schluein
Tel. 081 920 00 20

Allmeindstrasse 22
Postfach 64
8716 Schmerikon
Tel. 055 286 90 90

Rheinstrasse
9475 Sevelen
Tel. 081 785 28 51

Muttenstrasse 18
4500 Solothurn
Tel. 032 625 61 61
Tel. 032 625 61 12

Bogenstrasse 14
9000 St. Gallen
Tel. 071 274 52 50
Tel. 071 274 52 59

Eichmattweg 7a
3600 Thun
Tel. 033 224 08 13

Durisolstrasse 6
5612 Villmergen
Tel. 056 525 02 20

Müllerstrasse 3
8604 Volketswil
Tel. 043 399 44 00

Zürcherstrasse 71
8620 Wetzikon
Tel. 052 244 01 92

Glärnisstrasse 39
9500 Wil
Tel. 071 929 96 40
Tel. 071 929 96 00

Menznauerstrasse 34
6130 Willisau
Tel. 041 984 01 90

Industriestrasse 18
8404 Winterthur
Tel. 052 238 14 44

Hegmattenstrasse 24/26
8404 Winterthur
Tel. 052 244 01 40

RichnerLAB
Marktgasse 18
8400 Winterthur
Tel. 052 244 01 44

St. Gallerstrasse 172
8411 Winterthur-Grüze
Tel. 052 235 14 00

Förrlibuckstrasse 110
8005 Zürich
Tel. 044 272 02 40

Staffelstrasse 12
8045 Zürich
Tel. 044 202 53 90

Westschweiz / Suisse romande / Svizzera romanda:

Gétaz-Miauton

Rte des Marais 3
1860 Aigle
Tel. 024 468 61 00

Rue des Usiniers 3
1630 Bulle
Tel. 026 919 77 21

Rte de Fribourg 1
1630 Bulle
Tel. 026 913 66 33

Z.I. Nord
Ch. Bas-de-Plan 1
1030 Bussigny
Tel. 021 702 04 15

Z.I. Sud
Ch. du Vallon 23
1030 Bussigny
Tel. 021 702 01 11

Rte des Jeunes 15-17
Halle I
1227 Carouge
Tel. 022 918 15 00

Rte des Jeunes 29
Halle H
1227 Carouge
Tel. 022 918 15 00

Rte du Pré 32
1660 Château-d'Œx
Tel. 026 924 24 24

Rte des Peupliers 17
1964 Conthey
Tel. 027 345 36 37

Ch. des Malpierrez 1
2088 Cressier
Tel. 032 755 96 96

Rue Clos-Donzel 6
2114 Fleurier
Tel. 032 861 17 80

Rte André Pillier 1
1762 Givisiez
Tel. 026 467 81 11

Rue des Champs 15
2300 La Chaux-de-Fonds
Tel. 032 926 04 26

Av. de Provence 14
1007 Lausanne
Tel. 021 620 63 21

Rue des Finettes 55
1920 Martigny
Tel. 027 723 16 80

Ch. des Mulets 3
2000 Neuchâtel
Tel. 032 727 73 00

Rte de Champ-Colin 15
1260 Nyon
Tel. 022 994 90 00

Z.I. En Grivaz
Rte de Granges 14
1607 Palézieux
Tel. 021 907 92 43

Rte de la Grosse-Pierre 16
1530 Payerne
Tel. 026 662 50 00

Rte de Raboud 2
1680 Romont
Tel. 026 651 96 00

Rue du Pré-de-la-Fontaine 8A
1242 Satigny
Tel. 022 753 93 10

Rue du Manège 10
3960 Sierre
Tel. 027 452 35 35

Z.I. la Veyre
1806 St-Légier
Tel. 021 923 37 00

Lonzastrasse 2
3930 Visp
Tel. 027 948 85 00

Kleegärtenstrasse
3930 Visp
Tel. 027 948 85 00

Rue des Uttins 29
1400 Yverdon-les-Bains
Tel. 024 424 86 00

Tessin / Ticino: Regusci Reco

Via San Gottardo 98
6500 Bellinzona 5
Tel. 091 820 23 23

Via Chiasso 25
6710 Biasca
Tel. 091 873 01 30

Via San Gottardo 14
6877 Coldrerio
Tel. 091 646 57 36

Via Saleggi 38
6600 Locarno
Tel. 091 751 15 26

Via dei Pioppi 10a
6616 Losone
Tel. 091 751 99 41

Via Cantonale 34a
6928 Manno
Tel. 091 222 17 50

Legende | Légende | Legenda

- Baumaterial
Matériaux de construction
Materiale da costruzione
- Haushaltsgeräte
Appareils électroménagers
Apparecchi elettrodomestici
- Haustechnik | Technique
du bâtiment | Impianti tecnici
- Holz | Bois | Legno
- Platten | Carrelages | Piastrelle
- Sanitär | Sanitaires | Sanitari
- Werkzeuge | Outillage | Utensili
- Aussengestaltung
Aménagements extérieurs
Allestimento esterno

Änderungen vorbehalten. Bitte konsultieren Sie für den aktuellen Stand und für die Öffnungszeiten unsere Webseite.
Sous réserve de modifications. Veuillez consulter notre site web pour connaître le statut actuel et pour les heures d'ouverture.
Salvo modifiche. Si prega di consultare il nostro sito web per lo stato attuale e gli orari di apertura.

Unsere Marken | Nos marques | I nostri marchi

BAUBEDARF **RICHNER** **GETAZ** **MIAUTON** **REGUSCI RECO**